



Ilumina tus espacios

CATÁLOGO

ILUMINACIÓN Y ARTEFACTOS ELÉCTRICOS

2023

INDICE GENERAL



Ilumina tus espacios

02 POLITICAS DE VENTA

- **Misión**
- **Políticas de venta y devolución**

04 INCANDESCENTES

- **Lámparas Vela**
- **Lámparas Bola**
- **Lámparas Tubulares**
- **Lámparas Spot**
- **Lámparas Vintage**
- **Lámparas Tipo Reflector**

10 TUBOS FLUORESCENTES

- **Tubos Circulares**
- **Tubos Circulares Dobles**
- **Tubos Fluorescentes**
- **Tubos Luz Negra con filtro**
- **Tubos Luz Negra sin filtro**
- **Tubos para Acuario**
- **Tubos Germicidas**

14 LÁMPARAS HALÓGENAS

- **Lámparas MR16**
- **Lámparas MR11**
- **Lámparas GU10**
- **Lámparas Cacahuete**
- **Lámparas AR111**

17 LÁMPARAS AHORRADORAS COMPACTAS

- **Lámparas espirales**
- **Lámparas PL**
- **Lámparas Luz Negra**
- **Lámparas UV**

20 LÁMPARAS Y TUBOS LED

- **Cacahuates LED**
- **Velas LED**
- **MR11 LED**
- **MR16 LED**
- **PAR LED**
- **AR111 LED**
- **Lámparas A60 LED**
- **Lámparas circulares LED**
- **Lámparas bala LED**
- **ST64 LED**
- **Lámparas Tubulares LED**
- **Lámparas tipo ventilador**
- **Tubos LED transparentes**
- **Tubos LED opalinos**

34 LUMINARIOS LED INTERIOR-EXTERIOR Y DE EMERGENCIA

- **Luminarios con rejilla**
- **Luminarios tipo barra**
- **Luminarios ultradelgados**
- **Luminarios interconectables**
- **Luminarios dirigibles**
- **Luminarios para empotrar**
- **Luminarios empotrables**
- **Luminarios circulares**

- **Luminarios cuadrados**
- **Luminarios de cortesía**
- **Luminarios suburbanos**
- **Luminarios campana**
- **Luminarios Industriales**
- **Reflectores LED**
- **Arbotantes LED**
- **Lámparas de emergencia**

48 LUMINARIOS

- **Canaletas autobalastadas**
- **Luminarios de empotrar**
- **Luminarios dirigibles**
- **Gabinetes**
- **Suburbanos**
- **A prueba de vapor**
- **Faroles**
- **Portalámparas**

52 ESPECIALIDADES VARIAS

- **Drivers**
- **Mata Insectos**
- **Fotoceldas**

57 ARTEFACTOS ELÉCTRICOS

- **Sockets**
- **Clavijas**
- **Contactos**
- **Bases**
- **Interruptores**

64 OFERTAS

INDICE POR CLAVES



Ilumina tus espacios

CLAVE	PÁG	CLAVE	PÁG	CLAVE	PÁG	CLAVE	PÁG
1040	44	CA1025F	5	FL15AQ	15	LMSKR	50
1042	44	CA1040	5	FL15BL	12	LYLED2	47
1044	44	CA1040F	5	FL15BLB	12	LUE3L	47
1045	44	CAN12078LED	53	FL15D	11	LUE5L	47
1050	44	CAN12078LED/MO	53	FL15GER	12	LULED2XLR	35
1052	44	CAN12078LED/PL	53	FL15DT4	11	LULED2XLR	35
1054	44	CAN12078X2LED/PL	53	FL17BF	12	LUSUB/NE	52
1056	44	CAN15	49	FL20BCT4	65	MDP17	55
1120	45	CAN20	49	FL20BL	12	MP10/BC	38
1125	45	CAN40	49	FL20BLB	12	MP10/LD	38
1130	44	CAN6078LED	53	FL20DT4	11	MP12/LD	38
1135	44	CIR12	26	FL20DT8	11	MP20/LD	38
1140	45	CIR18	26	FL21DT5	11	MP7/BC	38
1145	45	CIR24	26	FL24BFT5	11	MP7/LD	38
1150	45	CIR36	26	FL28BCT5	11	MR1110C	25
1155	45	CL473	51	FL28DT5	11	MR1135D	25
1160	45	CL477N	51	FL30DT8	11	MR1150D	25
1165	45	CL478	51	FL30GER	12	MR11PTDC	25
1210	46	CL200/LD	33	FL32D	12	MR11PTHC	25
1215	46	CM3025	6	FL35DT5	12	MR11FT1C	25
1220	46	CM3540	6	FL40BL	12	MR11LED4/BC	22
1225	46	CO273	50	FL40BLB	12	MR11LED4/LD	22
1230	46	CO275B	50	FL40UVG	13	MR167/COL	22
1235	46	CO275M	50	FL4BL	12	MR167DIM/BC	22
1240	46	CO275NA	50	FL4BLB	12	MR167DIM/LD	22
1245	46	CO278	50	FL4D	11	MR165MD7C/BC	22
5060	52	CO279	50	FL4FILED/BC	30	MR165MD7C/LD	22
12A60LED9/LD	24	CO280	50	FL4FILED/LD	30	P4540E26	8
25B10	5	CO281	50	FL54BCT5	65	P4540E26/HR	8
25F15	8	CO282	50	FL54DT5	11	PALED100	42
3U115MD/LD	27	CO285NA	51	FL58DT8	11	PALED50	42
3U75MD/LD	27	CO483	51	FL6BL	12	PAR20	16
40B10	5	COBY15/BC	67	FL6BLB	12	PAR205MD8/BC	23
40F15	8	COBY15/LD	67	FL6D	11	PAR205MD8/LD	23
4U185MD/LD	28	COBY20/BC	67	FL6BL	12	PAR205MD12/BC	23
4U255MD/LD	28	COBY20/LD	67	FL6BLB	12	PAR205MD12/LD	23
4U425MD/LD	28	CONVEXL90	42	FL6D	11	PAR205MD18/BC	23
7.5ML2	56	CONVEXL50	42	FL8GER	12	PAR205MD18/LD	23
A19	8	CONVEX50	42	FLAT10/BC	43	PL13/64	18
A198L875	8	CUAD20/LD	39	FLAT10/LD	43	PL13BL	18
A55LED7/RE	25	CUAD7/BC	67	FLAT100/BC	43	PL26/64	19
A603CCT9	25	CUAD7/LD	39	FLAT100/LD	43	PL2U13/64	19
A603DIM9/LD	25	CUT12/LD	39	FLAT150/LD	43	PL7BLB	18
A609LED127/BC	24	CUT18/LD	39	FLAT200/LD	43	PL9/64	18
A609LED127/LE	24	CUT24/LD	39	FLAT30/BC	43	PL9/UV	18
A60DIM4/BC	29	DIM3MR167/LD	23	FLAT30/LD	43	PLA400	61
A60DIM4/LD	29	DRV20-34W	47	FLAT50/BC	43	PLA401B	61
A60FILED4/BC	29	DRV4-6W	47	FLAT50/COL	43	PLA401M	61
A60FILED8/BC	29	DRV9-18W	47	FLAT50/LD	43	PLA401NA	61
A60LED9/BL	25	E12R35MD/BC	21	FLAT60/LD	43	PLA422	61
A60LED8C/LD	25	E12R35MD/LD	21	FS2	63	PL513/41	18
A60LED9/BC	24	E14R35MD/BC	21	FS4	63	PL513/64	18
A60LED9/LD	24	E14R35MD/LD	21	FSU	63	PL9/41	18
A60SEN9/LD	25	E17R35MD/BC	21	G25	8	P0101	58
A60SMD/COL	26	E17R35MD/LD	21	G455MD/COL	24	P0107	58
A65FC12/LD	25	ED120LED70/LD	31	G455MD6/BC	24	P0110	58
A70LED17/LD	24	ED90LED40/LD	31	G455MD6/LD	24	P0111	58
A80LED125OL	26	EM1005/BL	49	G4LED2/BC	21	P0127	58
ALUX12/BC	37	EM1005/SA	49	G4LED2/LD	21	P0128	58
ALUX12/LD	37	EM5LED/SA	36	G4R35MD/BC	21	P0129	58
ALUX3/BC	37	EM73B	50	G4R35MD/LD	21	P0130	58
ALUX3/LD	37	EM74	50	G50	5	P0131	58
ALUX7/BC	37	EMFDIR/BC	37	G50BC0	5	P0132	58
ALUX7/LD	37	EMFDIR/LD	37	G50	5	P0133	58
AR1135/34	15	EM8507/BL	49	G840F	16	P0171	58
AR111LED12/BC	24	EM8507/NE	49	G875F	16	P0178	58
AR111LED12/LE	24	EM8507/SA	49	G9R35MD/BC	21	P0210	58
AR15LED	39	EM8509/BLM	49	G9R35MD/LD	21	P0215	58
AR89/PL	68	EM8509/SA	49	GRILL	50	P0225	59
AR9GL/E27	40	EMR11LED/BC	37	GU10	50	P0227	59
AR9VA/E27	40	EMR11LED/LD	37	GU1050C	15	P0227C	59
ARRE15LED	39	EMSMD12/BC	37	GU10C0B7/BC	66	P0228	59
BA1/GR	52	EMSMD12/LD	37	GU10R35MD/BC	66	P0230	59
BABC	15	ENSM07/BC	37	GU10MSDIM/BC	66	P0240	59
BE1X20	55	ENSM07/LD	37	GU105MD7C/BC	23	P0327	59
BE1X40	55	ENSM09/BC	37	GU105MD7C/LD	23	P0410	59
BE1X40G10Q	55	ENSM09/LD	37	H118	60	POS26/GR	52
BE1X8	55	ES13G21/27	18	HYDR040	67	R14E1440	7
BE2X28	55	ES13G21/34	18	IN1X5/NE	65	R14E1740	7
BE2X40	55	ES145MD/BC	28	IN270	61	R39E17	7
BE2X14	55	ES145MD/LD	28	IN279	61	REK54LED/LD	35
BE2X28	55	ES235MD/BC	28	IN280	61	RLED150	42
BEMMY	67	ES235MD/LD	28	IN281	62	RLED200	42
BFC1000	56	ES345MD/LD	28	IN282	62	RP3BL/BC	40
BFL477	59	ES95MD/LD	28	IN283	62	RP3BL/LD	40
BFL480	59	ESP1512	19	IN284	62	RP3NE/BC	40
BFL482	59	EXNC	15	IN285	62	RP3NE/LD	40
BFL483	59	FA80/BL	51	IN286	62	RS8C	68
BFL485	59	FA80/NE	51	IN287	62	S11C	7
BFL486	59	FA95C	68	IN288	62	S1410	9
BFL490	59	FAN25	31	IN290	62	S1410/AM	9
BFL491	60	FAN39	31	IN295	62	S1410/AZ	9
BOWL	38	FAN50+7	66	IN472	62	S1410/RO	9
BR40CL	9	FAN52	31	IN475	62	S1410/VE	9
BR40RO	9	FAROLED	39	IN476	62	S14LED/AZ	29
C22LED/LD	26	FAROLEDPL	39	IN478	62	S14LED/AZ	29
C7.5/M	5	FC1000	56	INLED4	55	S14LED/CL	29
C7.5/AZ	5	FCL16/41	11	3C10	15	S14LED/RO	29
C7.5/CL	5	FCL22	11	3C20	15	S14LED/VE	29
C7.5/RO	5	FCL28/50	11	3C50	15	S145MD4/MO	65
C7.5/VE	5	FCL2C40/BF	11	3CD20	16	SKIN14	35
C7.5FILED/AZ	22	FCL32	11	3CD50	16	SKIN14/BC	35
C7.5FILED/BC	22	FCL38/50	11	3D100	16	SKIN18	35
C7.5FILED/LD	22	FCS	16	3D75	16	SKIN18/BC	35
C7.5FILED/MO	22	FFNC7.5	5	3DC20C	15	SKIN5	35
C7.5FILED/RO	22	FFNSTD	8	3DC50C	15	SKIN5/BC	35
C7.5FILED/ROS	22	FFT55LED	30	3D9100	16	SKIN9	35
C7.5FILED/VE	22	FL10BL	12	3DR4BLB	23	SKIN9/BC	35
C7.5LED/COL	22	FL13D	11	3DR5MD7C/LD	23	SKY10PL/BC	38
C925	5	FL14BCT5	11	LHADP	61	SKY10PL/LD	38
C940	5	FL14BFT5	11	LHADR	61	SKY15PL/BC	38
CA1025	5	FL14DT5	11	LMSK	60	SKY15PL/LD	38

En nuestra empresa, estamos comprometidos a:
Ofrecer a nuestros clientes de manera segura y confiable los artículos que requieren en variedad, calidad y precio de acuerdo a sus objetivos de mercado, que les permita alcanzar sus metas de negocio con un socio sólido y comprometido con ellos.



ilumina tus espacios

IMPORTACIONES MUSTRI S.A. DE C.V. se complace en presentar a sus clientes y amigos su catálogo 2023 de iluminación, artefactos eléctricos y especialidades varias, en donde encontrarán la más amplia gama de productos en:

- LÁMPARAS INCANDESCENTES
- LÁMPARAS FLUORESCENTES
- LÁMPARAS HALÓGENAS
- LÁMPARAS AHORRADORES DE ENERGÍA
- LÁMPARAS LED
- LUMINARIOS LED DE INTERIOR, EXTERIOR Y DE EMERGENCIA
- DECORATIVOS
- ARTICULOS VARIOS
- ARTEFACTOS ELÉCTRICOS

En esta edición encontrarán los mejores artículos que nos mantienen a la vanguardia de la tecnología de iluminación. Agradeciendo su preferencia, esperamos sea de su agrado y esto los lleve a tener excelentes ventas.

PARA GARANTIZAR SU CALIDAD, NUESTROS PRODUCTOS HAN SIDO PROBADOS, BAJO ESTRUCTAS NORMAS DE CALIDAD VIGENTES NACIONALES E INTERNACIONALES.



POLÍTICAS DE VENTA

1. PRECIOS:

Nuestros precios se encuentran en moneda nacional y son por unidad, cancelan todos los precios de catálogos anteriores, son L.A.B. (Libre a bordo) en México D.F. y área Metropolitana y están sujetos a cambios sin previo aviso.
Los precios no incluyen I.V.A.

2. PEDIDOS:

Todos los pedidos recibidos por los representantes de ventas o en nuestras oficinas están sujetos a la aprobación de nuestros departamentos de Ventas y Crédito y Cobranza. Únicamente se surtirán empaques cerrados, (según se indica en el catálogo). La facturación mínima será de \$15,000.00 (quince mil pesos).

3. INCIDENCIA DE EMBARQUE: (Si su orden de compra tiene una incidencia, favor de notificarlo inmediatamente al recibir la mercancía a su agente de ventas, mediante correo electrónico con copia a gerencia.logistica@lummi.com.mx para que le proporcionen las indicaciones para proceder con la incidencia).

Los fletes y seguro son por cobrar, por lo que el cliente deberá especificar la línea transportista de su preferencia en el pedido; en caso de no hacerlo se entiende que acepta la línea que designe IMPORTACIONES MUSTRI, S.A. DE C.V.

FORANEOS: Una vez que IMPORTACIONES MUSTRI S.A. DE C.V. coloca en el transporte la mercancía, no podrá hacerse responsable por el producto que llegué roto o faltante a su destino final, ya que todos los embarques se envían asegurados, la mercancía durante el traslado es por cuenta y riesgo del cliente. Para poder evitar alguna situación de producto roto o faltante es necesario revisar la mercancía, antes de firmar la hoja de conformidad que solicita la paquetería. En IMPORTACIONES MUSTRI S.A. DE C.V. cuidamos que todas las cajas vayan cerradas con una cinta blanca impresa con el logo de "LUMMI" IMPORTACIONES MUSTRI, S.A. DE C.V., la cual no debe ir violada, ni alterada, en caso contrario "no recibir esa caja" y ponerse en contacto de inmediato con su representante de ventas o al departamento de Logística.

LOCALES: En este caso IMPORTACIONES MUSTRI S.A. DE C.V. solicita revisar el material a detalle al momento de la entrega, si en ese momento hubiera producto roto o faltante que se demuestre durante la entrega de los operadores, IMPORTACIONES MUSTRI S.A. DE C.V. responderá por esa mercancía.

Una vez aceptada la mercancía y firmado de conformidad, se entiende que IMPORTACIONES MUSTRI S.A. DE C.V. se deslinda de cualquier producto que este roto o faltante ya sea en embarques Foráneos o Locales

NO SE ACEPTARÁ NINGUN TIPO DE INCIDENCIA PASADOS LOS 8 DÍAS DE SU RECEPCIÓN.

Sólo se entregan pedidos en territorio nacional. LAB CDMX y Área Metropolitana.

4. CONDICIONES DE PAGO Y DESCUENTOS:

Las condiciones de pago y descuentos serán tratadas directamente con el vendedor y/o con el Director de Ventas.

Cualquier duda o aclaración sobre su estado de cuenta, forma de pago, uso de CFI, complemento de pago, etc., comuníquese por email cyc@lummi.com.mx con el personal de Crédito y Cobranza o al teléfono (55) 5358-5800 ext. 2010.

4.1

Todos los pagos deberán ser depositados en nuestras cuentas mencionadas al calce, haciendo referencia del documento que está saldando, preferentemente enviar desglose y acuse de pago vía email a cyc@lummi.com.mx.

Sin ficha o comprobante de pago no se acreditará ningún pago. Así mismo, es responsabilidad del cliente realizar su pago en la fecha de vencimiento considerando la fecha factura y no la fecha de arribo de la mercancía. Los cheques y pagos recibidos como pago a la empresa son recibidos salvo buen cobro si estos son devuelto o no abonados en firme, causa un cargo del 10% del valor del cheque, más los gastos bancarios que se generen.

Los cheques deberán expedirse a nombre de IMPORTACIONES MUSTRI, S.A. DE C.V., e incluir la leyenda "Para abono a cuenta del beneficiario". Tanto los vendedores como nuestro personal, tienen prohibido recibir dinero en efectivo. Por lo cual no reconoceremos ni avalaremos pagos en efectivo que se le hayan entregado a los vendedores o al personal de la empresa, de lo contrario seguirá el adeudo a su cuenta, si usted desea realizar el pago en efectivo deberá depositar directamente a cualquiera de nuestras cuentas enviándolo por correo el comprobante de pago.

5. DEVOLUCIÓN DE MERCANCÍA:

(Si el cliente se equivocó de producto o ya no lo requiere) En caso de devolución injustificada se hará un cargo del 20% sobre el valor de la devolución, para cubrir los gastos de operación que esta origina. No hay cambios físicos, se elaborará nota de crédito por la diferencia. La mercancía en devolución deberá ser previamente notificada a su agente de ventas, mediante correo electrónico con copia a ventas@lummi.com.mx. El agente de ventas debe llenar el formato de devolución, el cual reenviará al área de ventas para su seguimiento. Así el área correspondiente le hará conocimiento por correo electrónico de los términos y la solución que se ofrece para concluir la devolución. **EN NINGUN CASO SE DEBERA ENTREGAR DEVOLUCIONES AL VENDEDOR YA QUE ESTA NO SERA PROCESADA. NO SE ACEPTARÁ NINGUN TIPO DE DEVOLUCIÓN PASADOS LOS 30 DÍAS DE SU FACTURACIÓN.**

6. GARANTÍA:

(En el caso de tener material a garantía, favor de notificarlo a su agente de ventas mediante correo electrónico con copia a cyc@lummi.com.mx para que le proporcionen las indicaciones para proceder con la garantía).

La mercancía rota, reparada o usada no tiene garantía.

Para los focos, únicamente se recibirán los que al ser probados por primera vez no enciendan, en este caso favor de notificarlo.

6.1

GARANTIA DE RESPALDO PARA EL DISTRIBUIDOR: IMPORTACIONES MUSTRI S.A de C.V respetará las Políticas de Garantía que viene dentro de los productos para el cliente final, el cual en caso de querer proceder deberá seguir los lineamientos que se le solicita en dicha hoja que se encuentra dentro de los empaques.

NO SE ACEPTARÁ NINGUN TIPO DE GARANTIA PASADOS LOS 60 DÍAS DE SU FACTURACIÓN.

7. DEVOLUCIÓN:

(Si su orden de compra tiene una devolución favor de notificarlo a su agente de ventas mediante correo electrónico con copia a cyc@lummi.com.mx para que le proporcione las indicaciones para proceder con la devolución)

Cuando la devolución es imputable a IMPORTACIONES MUSTRI S.A de C.V: No tendrá ningún tipo de cargo por hacer la devolución, si después del diagnóstico, se acepta la devolución, se procederá a realizar nota de crédito, no hay cambios físicos.

Cuando la devolución es imputable al cliente: Se hará un cargo del 20% sobre el valor de la devolución, para cubrir los gastos de operación que esta origina. Se elaborará nota de crédito por la diferencia, no hay cambios físicos.

*La Nota de Crédito está sujeta a cómo recibe el producto el área técnica de **IMPORTACIONES MUSTRI S.A de C.V***

NO SE ACEPTARÁ NINGUN TIPO DE DEVOLUCIÓN PASADOS LOS 30 DÍAS DE SU FACTURACIÓN.

****Les pedimos no descontar nada del pago de sus facturas sin previa autorización de crédito y cobranza, ya que esto sólo causará diferencias en su estado de cuenta y se tendrán que detener sus pedidos hasta que la diferencia sea aclarada y saldada****

8. LAS CUENTAS A NOMBRE DE IMPORTACIONES MUSTRI S.A. DE C.V.



CONVENIO CIE:

777129

(Solicitar referencia al Depto. de Crédito y Cobranza)



CUENTA CONCENTRADORA:

0325369888

(Solicitar referencia al Depto. de Crédito y Cobranza)

Le informamos que sólo en caso de pagos con SPEI tenemos una cuenta especial, favor de solicitarla en el Depto. de Crédito y Cobranza. Favor de enviar su ficha a los siguientes correos: cyc@lummi.com.mx y credito@lummi.com.mx para poder acreditar su pago.



INCANDESCENTES

E12

C7.5 Vela Transparente Fijo



Clave



Clave	Watts	Volts	Amp.	Aper.	Temp.	Luz	Precio
C7.5/CL	7.5W	130V	0.057	360°	2700°K	Cálida	\$3.50
C7.5/AZ	7.5W	130V	0.057	360°	2700°K	Azul	\$3.50
C7.5/VE	7.5W	130V	0.057	360°	2700°K	Verde	\$3.50
C7.5/RO	7.5W	130V	0.057	360°	2700°K	Roja	\$3.50
C7.5/AM	7.5W	130V	0.057	360°	2700°K	Amarilla	\$3.50

Acabado: Cubierta de cristal transparente



FFNC7.5 Vela Transparente
Flicker Neón Oscilante



Clave



Clave	Watts	Volts	Amp.	Aper.	Temp.	Luz	Precio
FFNC7.5	3W	130V	0.23	360°	2700°K	Cálida	\$15.00

Acabado: Cubierta de cristal transparente



C9 Vela Chica Transparente



Clave



Clave	Watts	Volts	Amp.	Aper.	Temp.	Luz	Precio
C925	25W	130V	0.196	360°	2700°K	Cálida	\$9.00
C940	40W	130V	0.30	360°	2700°K	Cálida	\$9.00

Acabado: Cubierta de cristal transparente



B10 Vela Transparente Candelabra Liso



Clave



Clave	Watts	Volts	Amp.	Aper.	Temp.	Luz	Empaque	Precio
25B10	25W	130V	0.196	360°	2700°K	Cálida	500/25	\$8.80
40B10	40W	130V	0.30	360°	2700°K	Cálida	500/25	\$8.80

Acabado: Cubierta de cristal transparente



CA10 Vela Punta curva



Clave



Clave	Watts	Volts	Amp.	Aper.	Temp.	Luz	Precio
CA 1025	25W	130V	0.196	360°	2700°K	Cálida	\$10.00
CA 1025F	25W	130V	0.196	360°	2700°K	Cálida	\$10.00
CA 1040	40W	130V	0.30	360°	2700°K	Cálida	\$10.00
CA 1040F	40W	130V	0.30	360°	2700°K	Cálida	\$10.00

Acabado: Para CA1025 y CA1040 la cubierta es de cristal transparente
Para CA1025F y CA1040F la cubierta es de cristal perlado



G50 Bola



Clave



Clave	Watts	Volts	Amp.	Aper.	Temp.	Luz	Precio
G50	40W	130V	0.314	360°	2700°K	Cálida	\$16.50
G50BCO	40W	130V	0.30	360°	2700°K	Cálida	\$16.50

Acabado: Para G50 la cubierta es de cristal transparente
Para G50BCO la cubierta es de cristal blanco



T20, T8 y T21 Transparente Tubular

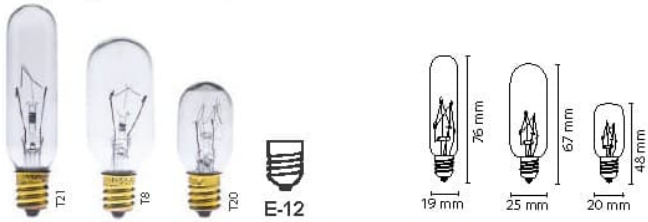

Clave	Watts	Volts	Amp.	Aper.	Temp.	Luz	Precio
T20X4815E12	15W	130V	0.118	360°	2700°K	Cálida	\$16.00
T825E12	25W	130V	0.196	360°	2700°K	Cálida	\$16.00
T2125E12	25W	130V	0.196	360°	2700°K	Cálida	\$16.00
T2140E12	40W	130V	0.30	360°	2700°K	Cálida	\$16.00

Acabado: Cubierta de cristal transparente Bulbos T20, T21 y T8



E14 T21 Transparente Tubular



Clave	Watts	Volts	Amp.	Aper.	Temp.	Luz	Precio
T2125E14	25W	130V	0.196	360°	2700°K	Cálida	\$16.00
T2140E14	40W	130V	0.30	360°	2700°K	Cálida	\$16.00

Acabado: Cubierta de cristal transparente Bulbo T21



T1654 Transparente Tubular



Clave	Watts	Volts	Amp.	Aper.	Temp.	Luz	Precio
T1654	6/10W	130V	0.07	360°	2700°K	Cálida	\$16.00

Acabado: Cubierta de cristal transparente



ST23 Transparente Chato



Clave	Watts	Volts	Amp.	Aper.	Temp.	Luz	Precio
ST23	15W	130V	0.118	360°	2700°K	Cálida	\$16.00

Acabado: Cubierta de cristal transparente



CM35 Vela Transparente Rizado



Clave	Watts	Volts	Amp.	Aper.	Temp.	Luz	Precio
CM3525	25W	130V	0.196	360°	2700°K	Cálida	\$10.00
CM3540	40W	130V	0.30	360°	2700°K	Cálida	\$10.00

Acabado: Cubierta de cristal transparente



R14 Perlado Baby Spot



Clave	Watts	Volts	Amp.	Aper.	Temp.	Luz	Precio
R14E1440	40W	130V	0.30	360°	2700°K	Cálida	\$27.00

Acabado: Cubierta de cristal perlado



E17

R14 Perlado Baby Spot



Clave	Watts	Volts	Amp.	Aper.	Temp.	Luz	Precio
R14E1740	40W	130V	0.30	360°	2700°K	Cálida	\$27.00

Acabado: Cubierta de cristal perlado



R39 Espejo Transparente



Clave	Watts	Volts	Amp.	Aper.	Temp.	Luz	Precio
R39E17	30W	130V	0.236	360°	2700°K	Cálida	\$18.00

Nota: Especial para lámpara de "Lava"

Acabado: Cubierta de espejo transparente



T20X48 Transparente Bayoneta



Clave	Watts	Volts	Amp.	Aper.	Temp.	Luz	Precio
T20X48 15BAY	15W	130V	0.118	360°	2700°K	Cálida	\$16.00

Acabado: Cubierta de cristal transparente



T20, T8 y T21 Transparente Tubular



Clave	Watts	Volts	Amp.	Aper.	Temp.	Luz	Precio
T20X48 15E17	15W	130V	0.118	360°	2700°K	Cálida	\$16.00
T825E17	25W	130V	0.196	360°	2700°K	Cálida	\$16.00
T2140E17	40W	130V	0.30	360°	2700°K	Cálida	\$16.00

Acabado: Cubierta de cristal transparente



S11 Bola



Clave	Watts	Volts	Amp.	Aper.	Temp.	Luz	Precio
S11C	40W	130V	0.30	360°	2700°K	Cálida	\$15.00

Acabado: Cubierta de cristal transparente



T6.5 Transparente Tubular



Clave	Watts	Volts	Amp.	Aper.	Temp.	Luz	Precio
T6.540	40W	130V	0.30	360°	2700°K	Cálida	\$28.00

Acabado: Cubierta de cristal transparente



LAMPARAS DECORATIVAS Tipo Vintage

2,000 HORAS DE VIDA

E26

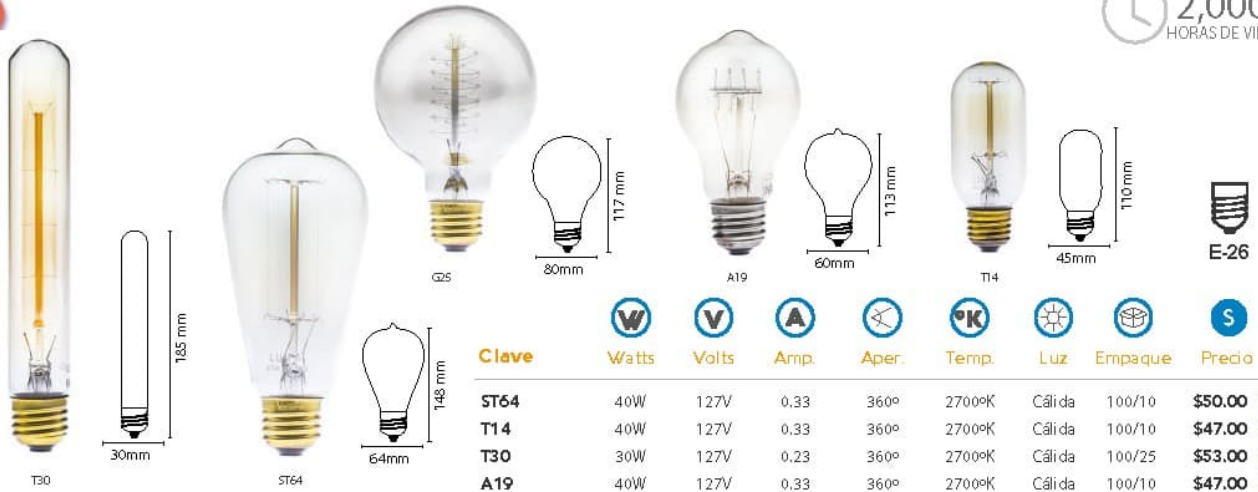

Acabado: Cubierta de cristal transparente

Clave

	Watts	Volts	Amp.	Aper.	Temp.	Luz	Empaque	Precio
ST64	40W	127V	0.33	360°	2700°K	Cálida	100/10	\$50.00
T14	40W	127V	0.33	360°	2700°K	Cálida	100/10	\$47.00
T30	30W	127V	0.23	360°	2700°K	Cálida	100/25	\$53.00
A19	40W	127V	0.33	360°	2700°K	Cálida	100/10	\$47.00
G25	40W	127V	0.33	360°	2700°K	Cálida	50/10	\$55.00

P45 Transparente Tipo Corona



Clave

	Watts	Volts	Amp.	Aper.	Temp.	Luz	Precio
P4540E26	40W	130V	0.30	360°	2700°K	Cálida	\$8.00
P4540E26/HR*	40W	130V	0.30	360°	2700°K	Cálida	\$12.00

Acabado:

Cubierta de cristal transparente.
*P4540E26/HR: Especial para temperaturas altas y bajas, cristal resistente, ideal para hornos y refrigeradores

250/25

A19 Luz Negra Con Filtro



Clave

	Watts	Volts	Amp.	Aper.	Temp.	Luz	Precio
A19BLB75	75W	127V	0.590	360°	2700°K	UV	\$36.00

Acabado: Cubierta de cristal transparente con filtro BLB

100/10

FFNSTD Transparente Flicker Neón Oscilante



Clave

	Watts	Volts	Amp.	Aper.	Temp.	Luz	Precio
FFNSTD	3W	130V	0.23	360°	2700°K	Cálida	\$18.00

Acabado: Cubierta de cristal transparente

500/25

F15 Transparente Flama STD



Clave

	Watts	Volts	Amp.	Aper.	Temp.	Luz	Precio
25F15	25W	130V	0.196	360°	2700°K	Cálida	\$13.50
40F15	40W	130V	0.30	360°	2700°K	Cálida	\$13.50

Acabado: Cubierta de cristal transparente

100/10

Bajo precio

T10 Tubular Transparente



Clave



Clave	Watts	Volts	Amp.	Aper.	Temp.	Luz	Precio
T1040	40W	130V	0.30	360°	2700°K	Cálida	\$26.00

Acabado: Cubierta de cristal transparente



VE Vela Liso STD



Clave



Clave	Watts	Volts	Amp.	Aper.	Temp.	Luz	Precio
VE25	25W	130V	0.196	360°	2700°K	Cálida	\$6.00
VE40	40W	130V	0.30	360°	2700°K	Cálida	\$6.00

Acabado: Cubierta de cristal transparente



S14 Transparente Tipo Anuncio

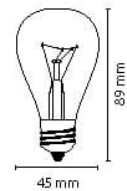

Clave



Clave	Watts	Volts	Amp.	Aper.	Temp.	Luz	Precio
S1410	10 W	130V	0.76	360°	2700°K	Cálida	\$8.00
S1410/AZ	10 W	130V	0.76	360°	2700°K	Azul	\$9.00
S1410/VE	10 W	130V	0.76	360°	2700°K	Verde	\$9.00
S1410/RO	10 W	130V	0.76	360°	2700°K	Roja	\$9.00
S1410/AM	10 W	130V	0.76	360°	2700°K	Amarilla	\$9.00

Acabado: Cubierta de cristal transparente



Luz Infrarroja



Recomendado para uso medicinal

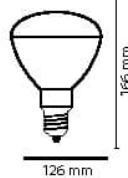

Clave



Clave	Watts	Volts	Aper.	Luz	Precio
BR40/RO	250W	127V	360°	Infrarroja	\$160.00

Acabado: Cristal espejado



Tipo Reflector

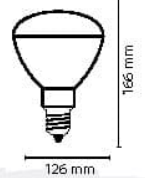

Clave



Clave	Watts	Volts	Aper.	Temp.	Luz	Precio
BR40/CL	250W	127V	360°	2700°K	Cálida	\$70.00

Acabado: Cristal espejado





TUBOS FLUORESCENTES

T5 Tubos Circulares

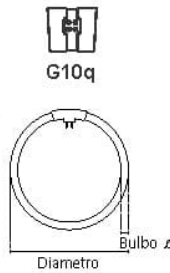

30,000 HORAS DE VIDA IP20

Clave	Diametro	Bulbo	Watts	Volts	Amp.	Apertura	Temp.	Luz	Empaque	Precio
FCL16/41	138 mm	T5/16mm	16 W	130V	0.125	360°	4100°K	Neutra	100/10	\$90.00
FCL22	185 mm	T5/16mm	22 W	130V	0.173	360°	6400°K	Blanca	40/10	\$68.00
FCL28/50	225 mm	T5/16mm	28 W	130V	0.220	360°	5000°K	Neutra	50/10	\$96.00
FCL32	275 mm	T5/16mm	32 W	130V	0.251	360°	6400°K	Blanca	40/10	\$79.00
FCL38/50	300 mm	T5/16mm	38 W	130V	0.251	360°	5000°K	Neutra	50/10	\$95.00

T5 2C Tubos Circulares



30,000 HORAS DE VIDA IP20

Clave	Diametro	Bulbo	Watts	Volts	Amp.	Apertura	Temp.	Luz	Precio
FCL2C40/BF	138 mm	T5/16mm	40 W	130V	0.314	360°	4100°K	Neutra	\$143.00

20/5

T4 Tubos Fluorescentes

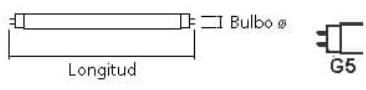

30,000 HORAS DE VIDA IP20

Clave	Longitud	Bulbo	Watts	Volts	Amp.	Apertura	Temp.	Luz	Precio
FL16DT4	470 mm	T4/12.5mm	16W	130V	0.125	360°	6400°K	Blanca	\$28.00
FL20DT4	565 mm	T4/12.5mm	20W	130V	0.157	360°	6400°K	Blanca	\$27.00

100/10

T5 Tubos Fluorescentes



30,000 HORAS DE VIDA IP20

Clave	Longitud	Bulbo	Watts	Volts	Amp.	Apertura	Temp.	Luz	Empaque	Precio
FL4D	150 mm	T5/16mm	4 W	130V	0.031	360°	6400°K	Blanca	250/10	\$14.00
FL6D	226 mm	T5/16mm	6 W	130V	0.047	360°	6400°K	Blanca	250/10	\$14.00
FL8D	302 mm	T5/16mm	8 W	130V	0.062	360°	6400°K	Blanca	250/10	\$16.00
FL13D	531 mm	T5/16mm	13 W	130V	0.102	360°	6400°K	Blanca	200/10	\$18.00
FL14DT5	563 mm	T5/16mm	14 W	130V	0.110	360°	6400°K	Blanca	100/25	\$29.00
FL14BFT5	563 mm	T5/16mm	14 W	130V	0.110	360°	4100°K	Neutra	100/25	\$29.00
FL14BCT5	563 mm	T5/16mm	14 W	130V	0.110	360°	3000°K	Cálida	100/25	\$29.00
FL21DT5	863 mm	T5/16mm	21 W	130V	0.165	360°	6400°K	Blanca	100/25	\$44.00
FL24BFT5	560 mm	T5/16mm	24 W	130V	0.188	360°	4100°K	Neutra	100/25	\$50.00
FL28DT5	1163 mm	T5/16mm	28 W	130V	0.220	360°	6400°K	Blanca	100/25	\$50.00
FL28BCT5	1163 mm	T5/16mm	28 W	130V	0.220	360°	3000°K	Cálida	100/25	\$50.00
FL35DT5	1163 mm	T5/16mm	35 W	130V	0.275	360°	6400°K	Blanca	100/25	\$93.00
FL54DT5	1163 mm	T5/16mm	54 W	130V	0.425	360°	6400°K	Blanca	100/25	\$73.00

***NOTA:**
El voltaje y el amperaje indicados no son de la lámpara, sino que es el correspondiente entre el voltaje de entrada del balastro y el consumo (Watts) de la lámpara.

T8 Tubos Fluorescentes



30,000 HORAS DE VIDA IP20

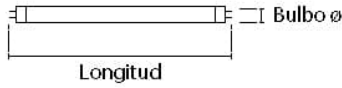

Clave	Longitud	Bulbo	Watts	Volts	Amp.	Apertura	Temp.	Luz	Empaque	Precio
FL15D	451 mm	T8/26mm	15 W	130V	0.118	360°	6400°K	Blanca	100/25	\$30.00
FL17BF	600 mm	T8/26mm	17 W	130V	0.133	360°	4100°K	Neutra	25/5	\$38.00
FL20DT8	604 mm	T8/26mm	20 W	130V	0.157	360°	6400°K	Blanca	25/5	\$38.00
FL30DT8	908 mm	T8/26mm	30 W	130V	0.263	360°	6400°K	Blanca	25/5	\$34.00
NUEVO FL32/41	1214 mm	T8/26mm	32 W	130V	0.251	360°	4100°K	Neutra	25/5	\$25.00
NUEVO FL32/64	1214 mm	T8/26mm	32 W	130V	0.251	360°	6400°K	Blanca	25/5	\$25.00
FL58DT8	1519 mm	T8/26mm	58 W	130V	0.456	360°	6400°K	Blanca	25/5	\$78.00

T5 / T8 BLB Tubos fluorescentes luz negra con filtro



15,000 HORAS DE VIDA IP20

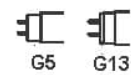

Clave	Longitud	Bulbo	Watts	Volts	Amp.	Apertura	Luz	Empaque	Precio
FL4BLB	150 mm	T5/16mm	4 W	130V	0.031	360°	UV	250/10	\$28.00
FL6BLB	226 mm	T5/16mm	6 W	130V	0.047	360°	UV	250/10	\$33.00
FL8BLB	302 mm	T5/16mm	8 W	130V	0.062	360°	UV	250/10	\$33.00
FL15BLB	451 mm	T8/26mm	15 W	130V	0.118	360°	UV	100/25	\$70.00
FL20BLB	604 mm	T8/26mm	20 W	130V	0.157	360°	UV	25/5	\$80.00
FL40BLB	1213 mm	T8/26mm	40 W	130V	0.314	360°	UV	25/5	\$125.00

T5 / T8 BL Tubos Fluorescentes Luz Negra sin filtro



15,000 HORAS DE VIDA IP20

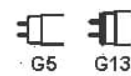
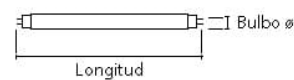

Clave	Longitud	Bulbo	Watts	Volts	Amp.	Apertura	Luz	Empaque	Precio
FL4BL	150 mm	T5/16mm	4W	130V	0.031	360°	UV	250/10	\$16.00
FL6BL	226 mm	T5/16mm	6W	130V	0.047	360°	UV	250/10	\$18.00
FL8BL	302 mm	T5/16mm	8W	130V	0.062	360°	UV	250/10	\$22.00
FL10BL	345 mm	T8/26mm	10W	130V	0.078	360°	UV	100/25	\$44.00
FL15BL	451 mm	T8/26mm	15W	130V	0.118	360°	UV	100/25	\$40.00
FL20BL	604 mm	T8/26mm	20W	130V	0.157	360°	UV	25/5	\$60.00
FL40BL	1214 mm	T8/26mm	40W	130V	0.314	360°	UV	25/5	\$90.00

T5 / T8 Tubos fluorescentes Germicida ultravioleta

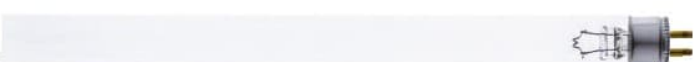

5,000 HORAS DE VIDA IP20

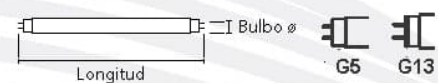

Acabado: Difusor de cristal transparente.

Clave	Longitud	Bulbo	Watts	Volts	Amp.	Apertura	Luz	Empaque	Precio
FL8GER	302 mm	T5/16mm	8 W	130V	0.062	360°	UV	250/10	\$55.00
FL15GER	451 mm	T8/26mm	15 W	130V	0.118	360°	UV	100/25	\$100.00
FL30GER	908 mm	T8/26mm	30 W	130V	0.236	360°	UV	25	\$160.00

*NOTA: El voltaje y el amperaje indicados no son de la lámpara, sino que es el correspondiente entre el voltaje de entrada del balastro y el consumo (Watts) de la lámpara.



Ilumina tus espacios

TUBOS FLUORESCENTES

T8 Tubo Fluorescente Grolux para acuario

5,000 HORAS DE VIDA **IP20**

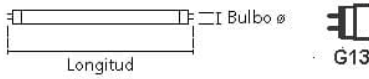

Clave

Longitud Bulbo Watts Volts Amp. Apertura Luz Precio

Acabado: Difusor de cristal blanco.

FL15AQ

451 mm T8/12.5mm 15 W 130V 0,118 360° Rosado \$40.00

*NOTA: El voltaje y el amperaje indicados no son de la lámpara, sino que es el correspondiente entre el voltaje de entrada del balastro y el consumo (Watts) de la lámpara.

100/5

T8 Tubo Fluorescente UVC + Ozono

5,000 HORAS DE VIDA **IP20**

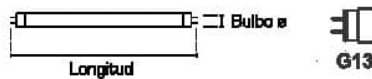

Clave

Longitud Bulbo Watts Volts Amp. Apertura Luz Precio

Acabado: Difusor de cristal transparente.

FL40UVC

1210 mm T8/12.5mm 36W 127V 0,26A 360° UVC \$140.00

25/5

Bajo precio

Tubo sanitizante UVC + Ozono

FL40UVC

Manten tus espacios libres de VIRUS, bacterias y otros patógenos.

Características:

- 135µw/cm2
- De uso Interior
- Esterilización y desinfección
- Hasta 40m² de esterilización
- NO tiene esterilización de esquina muerta

Adecuado para:

Hogar

Escuela

Restaurante

Oficina

Hospital

*Se puede utilizar con cualquier balastro para tubo fluorescente

*NOTA: El voltaje y el amperaje indicados no son de la lámpara, sino que es el correspondiente entre el voltaje de entrada del balastro y el consumo (Watts) de la lámpara.



LÁMPARAS HALÓGENAS

MR16 con cubierta JDC 127V



Clave

Clave	Watts	Volts	Amp.	Aper.	Temp.	Luz	Precio
JDC20C	20 W	130V	0.157	38°	2700°K	Cálida	\$20.00
JDC50C	50 W	130V	0.393	38°	2700°K	Cálida	\$20.00

Acabado: Cuerpo de cristal platinado
Difusor (cubierta) de cristal transparente



MR16 con cubierta 12V



Clave

Clave	Watts	Volts	Amp.	Aper.	Temp.	Luz	Precio
BABC	20W	12V	1.666	38°	2700°K	Cálida	\$16.00
EXNC	50W	12V	4.166	38°	2700°K	Cálida	\$16.00

Acabado: Cuerpo de cristal platinado
Difusor (cubierta) de cristal transparente



MR11 sin cubierta 127V



Clave

Clave	Watts	Volts	Amp.	Aper.	Temp.	Luz	Precio
MR1135D	35W	130V	0.275	38°	2400°K	Cálida	\$17.00
MR1150D	50W	130V	0.393	38°	2400°K	Cálida	\$17.00

Acabado: Cuerpo de cristal platinado
Difusor de cristal transparente



MR11 con cubierta 12V



Clave

Clave	Watts	Volts	Amp.	Aper.	Temp.	Luz	Precio
MR1110C	10 W	12V	0.833	38°	3000°K	Cálida	\$25.00
MR11FTDC	20 W	12V	1.666	38°	3000°K	Cálida	\$15.00
MR11FTHC	35 W	12V	2.916	38°	3000°K	Cálida	\$15.00

Acabado: Cuerpo de cristal platinado
Difusor (cubierta) de cristal transparente



GU10 con cubierta 127V



Clave

Clave	Watts	Volts	Amp.	Aper.	Temp.	Luz	Empaque	Precio
GU1050C	50W	130V	0.393	38°	3000°K	Cálida	100/25	\$27.00

Acabado: Cuerpo de cristal platinado
Difusor (cubierta) de cristal transparente



JC Cacahuete 12V



Clave

Clave	Watts	Volts	Amp.	Aper.	Temp.	Luz	Med. [axb/mm]	Emp	Precio
JC10	10W	12V	0.833	360°	2400°K	Cálida	8 x 30	1000/50	\$9.00
JC20	20W	12V	1.666	360°	2400°K	Cálida	8 x 30	1000/50	\$9.00
JC50	50W	12V	4.166	360°	2400°K	Cálida	10 x 44	1000/50	\$9.00

Acabado: Cuerpo de cristal transparente



LÁMPARAS HALÓGENAS

Ilumina tus espacios

JCD Cacahuete 127 V



Clave	Watts	Volts	Amp.	Aper.	Temp.	Luz	Med. (axb/mm)	Precio
JCD20	20 W	127V	0.157	360°	2400°K	Cálida	12 x 48	\$14.50
JCD50	50 W	127V	0.393	360°	2400°K	Cálida	12 x 48	\$14.50
G940F	40 W	130V	0.314	360°	2400°K	Cálida	12 x 50	\$23.00
G975F	75 W	130V	0.590	360°	2400°K	Cálida	12 x 50	\$23.00

Acabado: JCD Cuerpo de cristal transparente
G9 Cuerpo de cristal opalino

1000/25

JDD Doble Encapsulado



Clave	Watts	Volts	Amp.	Aper.	Temp.	Luz	Precio
JDD100	100W	127V	0.787	360°	2400°K	Cálida	\$83.00

Acabado: Cuerpo de cerámica
Difusor de cristal transparente

150/10

REFLECTOR Tipo Par



Clave	Watts	Volts	Amp.	Aper.	Temp.	Luz	Precio
PAR20	50 W	130V	0.393	30°	2400°K	Cálida	\$72.00

Acabado: Cuerpo de cristal platinado
Difusor de cristal transparente facetado
de alta resistencia

100/10

JD Minican



Clave	Watts	Volts	Amp.	Aper.	Temp.	Luz	Precio
JD75	75W	130V	0.590	360°	2400°K	Cálida	\$50.00
JD100	100W	130V	0.787	360°	2400°K	Cálida	\$50.00

Acabado: Cuerpo de cerámica
Difusor de cristal transparente

500/25

AR111

NUEVO



Clave	Watts	Volts	Amp.	Aper.	Temp.	Luz	Precio
AR11150/24	50 W	12V	4.166	24°	2400°K	Cálida	\$95.00
AR11150/6	50 W	12V	4.166	6°	2400°K	Cálida	\$95.00

Acabado: Cuerpo de lámina platinada
Difusor especular de lámina platinada

Nota: El foco es intercambiable por el modelo JC50

50/10

LÁMPARA Proyección y Fotografía



Clave	Watts	Volts	Temp.	Luz	Base	Med. (axb/mm)	Uso	Precio
FCS	150 W	24V	3400°K	Cálida	GX5.3	44.5 x 51	Proyección	\$89.00

Acabado: Cuerpo cristal transparente

500/10



**LÁMPARAS
AHORRADORAS
COMPACTAS**

G21 Espiral Mini



Clave	Watts	Volts	Amp.	Aper.	Temp.	Luz	Precio
ES13G21/27	13 W	130V	0.102	360°	2700°K	Cálida	\$96.00
ES13G21/64	13 W	130V	0.102	360°	6400°K	Blanca	\$96.00

Acabado: Cubierta de cristal blanco.
Requiere un balastro remoto no incluido.



PLES13 Espiral 4 Pines



Clave	Watts	Volts	Amp.	Aper.	Temp.	Luz	Precio
PLES13/41	13W	130V	0.102	360°	4100°K	Neutra	\$56.00
PLES13/64	13W	130V	0.102	360°	6400°K	Blanca	\$56.00

Acabado: Cubierta de cristal blanco.
Requiere un balastro remoto no incluido.



PL9 y PL13 "1U"



Clave	Watts	Volts	Amp.	Aper.	Temp.	Luz	Med. (axb/mm)	Precio
PL9/64	9W	130V	0.070	360°	6400°K	Blanca	167 x 27	\$36.00
PL13/64	13W	130V	0.102	360°	6400°K	Blanca	177 x 27	\$39.00

Acabado: Cubierta de cristal blanco.
Requiere un balastro remoto no incluido.



PL Luz Negra BLB "1U"



Clave	Watts	Volts	Amp.	Aper.	Luz	Med. (axb/mm)	Precio
PL7BLB	7W	130V	0.055	360°	UV	137 x 27	\$45.00
PL13BLB	13W	130V	0.102	360°	UV	177 x 27	\$51.00

Acabado: Cubierta de cristal BLB.
Requiere un balastro remoto no incluido.



PL Ultravioleta BLB "1U" Secador de Resinas



Clave	Watts	Volts	Amp.	Aper.	Temp.	Luz	Med. (axb/mm)	Precio
PL9/UV	9W	130V	0.070	360°	-	UV	167 x 27	\$77.00

Acabado: Cubierta de cristal blanco.
Requiere un balastro remoto no incluido.



PLL 4 Pines "1U"



Clave	Watts	Volts	Amp.	Aper.	Temp.	Luz	Med. (axb/mm)	Precio
PLL9/41	9W	130V	0.070	360°	4100°K	Neutra	145 x 27	\$35.00

Acabado: Cubierta de cristal blanco.
Requiere un balastro remoto no incluido.



*Nota: El voltaje y el amperaje indicados no son de la lámpara, sino que es el correspondiente entre el voltaje de entrada del balastro y el consumo (Watts) de la lámpara.



Ilumina tus espacios

LÁMPARAS AHORRADORAS

PL13 Y PL26 "2U"

DULUX



PL26

G24q-3

PL2U13

Gx23-2



Clave

Watts

Volts

Amp.

Aper.

Temp.

Luz

Med. (luxb/mm)

Emp.

Precio

PL2U13/64 13 W 130V 0.102 360° 6400°K Blanca 115 x 34 100/10 \$41.00

PL26/64 26 W 130V 0.204 360° 6400°K Blanca 173 x 27 100/25 \$48.00

Acabado: Cubierta de cristal blanco.

Requiere un balastro remoto no incluido.

ESPIRAL AUTOBALASTRADO

12V



E-26



5,000 HORAS DE VIDA

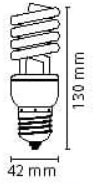

Clave

Watts

Volts

Amp.

Aper.

Temp.

Luz

Precio

ESP1512 15W 12V 0.95 360° 6400°K Blanca \$100.00

Acabado: Cubierta de cristal blanco.

Lámpara autobalastada



*Nota: El voltaje y el amperaje indicados no son de la lámpara, sino que es el correspondiente entre el voltaje de entrada del balastro y el consumo (Watts) de la lámpara.





LÁMPARAS Y TUBOS LED

G4 SMD RESINA 12V AC/DC

12V



35,000 HORAS DE VIDA



Clave

Watts Volts Amp. Aper. Lumen Temp. Luz Precio

G4LED2/BC	2W	12V	0.015	360°	140	3000°K	BC	\$26.00
G4LED2/LD	2W	12V	0.015	360°	140	6400°K	LD	\$26.00

Acabado: Cuerpo y difusor de resina transparente



G4 SMD RESINA

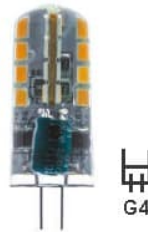

35,000 HORAS DE VIDA

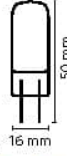

Clave

Watts Volts Amp. Aper. Lumen Temp. Luz Precio

G4R3 SMD/BC	3W	85/265V	0.023	360°	190	3000°K	BC	\$37.00
G4R3 SMD/LD	3W	85/265V	0.023	360°	190	6400°K	LD	\$37.00

Acabado: Cuerpo y difusor de resina transparente



G9 SMD RESINA



35,000 HORAS DE VIDA

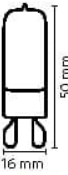

Clave

Watts Volts Amp. Aper. Lumen Temp. Luz Precio

G9R3SMD/BC	3W	85/265V	0.023	360°	190	3000°K	BC	\$37.00
G9R3SMD/LD	3W	85/265V	0.023	360°	190	6400°K	LD	\$37.00

Acabado: Cuerpo y difusor de resina transparente



T20 E12 SMD RESINA



15,000 HORAS DE VIDA



Clave

Watts Volts Amp. Aper. Lumen Temp. Luz Precio

E12R3SMD/BC	3W	85/265V	0.023	360°	180	3000°K	BC	\$35.00
E12R3SMD/LD	3W	85/265V	0.023	360°	180	6400°K	LD	\$35.00

Acabado: Cuerpo y difusor de resina transparente



T20 E14 SMD RESINA



15,000 HORAS DE VIDA

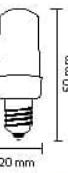

Clave

Watts Volts Amp. Aper. Lumen Temp. Luz Precio

E14R3SMD/BC	3W	85/265V	0.023	360°	200	3000°K	BC	\$35.00
E14R3SMD/LD	3W	85/265V	0.023	360°	200	6400°K	LD	\$35.00

Acabado: Cuerpo y difusor de resina transparente



T20 E17 SMD RESINA



15,000 HORAS DE VIDA



Clave

Watts Volts Amp. Aper. Lumen Temp. Luz Precio

E17R3SMD/BC	3W	85/265V	0.023	360°	180	3000°K	BC	\$35.00
E17R3SMD/LD	3W	85/265V	0.023	360°	180	6400°K	LD	\$35.00

Acabado: Cuerpo y difusor de resina transparente



LÁMPARAS LED

Ilumina tus espacios

T20 LED



E-12
E-14
E-17

20,000
HORAS DE VIDA

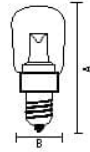

Clave	Watts	Volts	Amp.	Aper.	Lum.	Temp.	Luz	Med. (axb/mm)	Precio
T20LED/E12	1.5W	127V	0.011	360°	80	2700°K	BC	45 x 19	\$32.00
T20LED/E14	1.5W	127V	0.011	360°	80	2700°K	BC	49 x 19	\$32.00
T20LED/E17	1.5W	127V	0.011	360°	80	2700°K	BC	49 x 19	\$32.00

Acabado: Difusor de plástico transparente

1000/10

VELA LED C7.5



E-12

50,000
HORAS DE VIDA

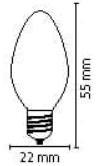

Clave	Watts	Volts	Amp.	Aper.	Lum.	Temp.	Luz	Precio
C7.5LED/COL	0.3W	130V	0.13	360°	22.5	-	Color	\$30.00

500/25

VELA FILED C7.5



E-12

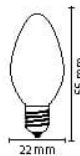

50,000
HORAS DE VIDA

Clave



Clave	Watts	Volts	Amp.	Aper.	Lum.	Temp.	Luz	Precio
C7.5FILED/LD	0.5W	127V	0.006	360°	22.5	6500°K	LD	\$13.00
C7.5FILED/BC	0.5W	127V	0.006	360°	70	2700°K	BC	\$13.00
C7.5FILED/RO	0.5W	127V	0.006	360°	10	-	Rojo	\$13.00
C7.5FILED/AZ	0.5W	127V	0.006	360°	35	-	Azul	\$13.00
C7.5FILED/VE	0.5W	127V	0.006	360°	20	-	Verde	\$13.00
C7.5FILED/ROS	0.5W	127V	0.006	360°	10	-	Rosa	\$13.00
C7.5FILED/MO	0.5W	127V	0.006	360°	10	-	Morado	\$13.00

Acabado: Difusor transparente

1000/50

MR11 LED

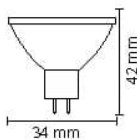

GZ4

25,000
HORAS DE VIDA

Acabado:
Cuerpo de aluminio y PVC blanco
Difusor de acrílico transparente

Clave



Clave	Watts	Volts	Amp.	Aper.	Lum.	Temp.	Luz	Precio
MR11LED4/BC	4W	127V	0.031	270°	300	2700°K	BC	\$50.00
MR11LED4/LD	4W	127V	0.031	270°	300	6500°K	LD	\$50.00

200/10

MR16 LED

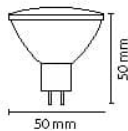

GX5.3

25,000
HORAS DE VIDA

Acabado:
Cuerpo de aluminio y PVC blanco
Difusor de acrílico transparente

Clave



Clave	Watts	Volts	Amp.	Aper.	Lum.	Temp.	Luz	Emp.	Precio
MR165MD7C/BC	7W	100/240	0.047	120°	520	3000°K	BC	100/10	\$27.00
MR165MD7C/LD	7W	100/240	0.047	120°	520	6400°K	LD	100/10	\$27.00
*MR167/COL	3W	127V	0.023	120°	-	-	Color	200/10	\$60.00

*Cambio cíclico de colores

MR16 LED DIMEABLE



GX5.3

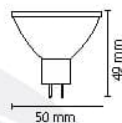

25,000
HORAS DE VIDA

Acabado:
Cuerpo de aluminio y PVC blanco
Difusor de acrílico transparente

NUEVO

MR167DIM/BC
MR167DIM/LD

Clave



Clave	Watts	Volts	Amp.	Aper.	Lum.	Temp.	Luz	Emp.	Precio
MR167DIM/BC	7W	85/145	0.061	120°	500	2700°K	BC	100/10	\$43.00
MR167DIM/LD	7W	100/130	0.061	120°	330	6400°K	LD	200/10	\$43.00

Bajo precio



Ilumina tus espacios

MR16 REGULABLE 3 PASOS CON APAGADOR

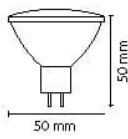

Apaga y enciende para cambiar los 3 niveles de intensidad



W	V	A	⊘	⊙	⊙K	\$
Watts	Volts	Amp.	Aper.	Lum.	Temp.	Precio

Clave	Watts	Volts	Amp.	Aper.	Lum.	Temp.	Precio
DIM3MR167/LD	7W	127V	0.072	38	500	Regulable	\$40.00

Acabado:
Cuerpo de aluminio y PVC blanco
Difusor de acrílico transparente



GU10 LED

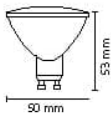

Acabado:
Cuerpo de aluminio y PVC blanco
Difusor de acrílico transparente

W	V	A	⊘	⊙	⊙K	☀	S
Watts	Volts	Amp.	Aper.	Lum.	Temp.	Luz	Precio

Clave	Watts	Volts	Amp.	Aper.	Lum.	Temp.	Luz	Precio
GU10SMD7C/BC	7W	100/240	0.055	120°	520	3000°K	BC	\$27.00 ✓
GU10SMD7C/LD	7W	100/240	0.055	120°	520	6400°K	LD	\$27.00 ✓

JDR LED

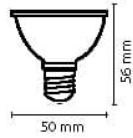

Clave	Watts	Volts	Amp.	Aper.	Lum.	Temp.	Luz	Precio
JDR5MD7C/LD	7W	100/240V	0.04	120°	450	6400°K	LD	\$33.00 ✓

Acabado:
Cuerpo de aluminio y plástico
Difusor de acrílico opalino



JDR4BLB Luz Negra

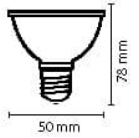

Clave	Watts	Volts	Amp.	Aper.	Temp.	Luz	Precio
JDR4BLB	4W	85/265V	0.04	360°	6400°K	LD	\$90.00 ✓



PAR20 / 30 / 38 LED



Acabado:
Cuerpo de aluminio y PVC blanco
Difusor de acrílico transparente facetado



Clave	Watts	Volts	Amp.	Aper.	Lum.	Temp.	Luz	Emp.	Precio
-------	-------	-------	------	-------	------	-------	-----	------	--------

PAR20SMD8/BC	8W	100/240V	0.06	120°	720	3000°K	BC	100/10	\$42.00
PAR20SMD8/LD	8W	100/240V	0.06	120°	720	6400°K	LD	100/10	\$42.00
PAR30SMD12/BC	12W	100/240V	0.094	120°	1080	3000°K	BC	50/10	\$77.00
PAR30SMD12/LD	12W	100/240V	0.094	120°	1080	6400°K	LD	50/10	\$77.00
PAR38SMD18/BC	18W	100/240V	0.145	120°	1620	3000°K	BC	20/10	\$108.00
PAR38SMD18/LD	18W	100/240V	0.145	120°	1620	6400°K	LD	20/10	\$108.00

✓ Bajo precio

LUMINARIO LED AR111

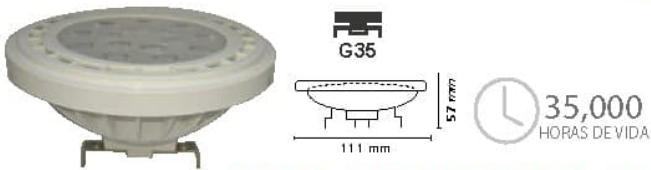

Clave	Watts	Volts	Amp.	Aper.	Lum.	Temp.	Luz	Precio
AR111LED12/BC	12W	90/265V	0.014	120°	1000	3000°K	BC	\$130.00
AR111LED12/LD	12W	90/265V	0.014	120°	1000	6400°K	LD	\$130.00

Acabado:
Cuerpo de aluminio y PVC blanco
Difusor de acrílico transparente facetado



G45 LED

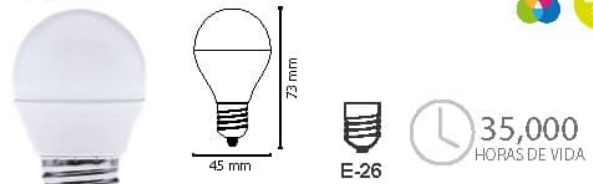

Clave	Watts	Volts	Amp.	Aper.	Lum.	Temp.	Luz	Precio
G45SMD6/BC	6 W	127V	0.047	360°	400	2700°K	BC	\$48.00
G45SMD6/LD	6 W	127V	0.047	360°	400	6400°K	LD	\$48.00
*G45SMD/COL	2 W	127V	0.015	360°	-	-	Color	\$50.00

Acabado:
Cuerpo de aluminio y PVC blanco
Difusor de acrílico opalino.

Nota:
Los colores se aprecian solo con lámparas encendidas.

* Cambio cíclico de colores



TIPO A-60 LED Multivoltaje



Clave	Watts	Volts	Amp.	Aper.	Lum.	Temp.	Luz	Precio
A60LED9/BC	9 W	127V	0.118	360°	810	3000°K	BC	\$21.00
A60LED9/LD	9 W	127V	0.118	360°	810	6400°K	LD	\$21.00

Acabado:
Cuerpo de aluminio y PVC blanco
Difusor de acrílico opalino.



TIPO A-60 LED 127V

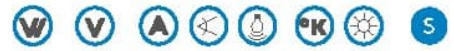

Clave	Watts	Volts	Amp.	Aper.	Lum.	Temp.	Luz	Precio
A609LED127/BC	9 W	127V	0.118	360°	810	2700°K	BC	\$18.00
A609LED127/LD	9 W	127V	0.118	360°	810	6400°K	LD	\$18.00

Acabado:
Cuerpo de aluminio y PVC blanco
Difusor de acrílico opalino.



TIPO A-60 LED

12V



Clave	Watts	Volts	Amp.	Aper.	Lum.	Temp.	Luz	Precio
12A60LED9/LD	9 W	12V	0.75	360°	810	6400°K	LD	\$49.00

Acabado:
Cuerpo de aluminio y PVC blanco
Difusor de acrílico opalino.



TIPO A-70 LED



Clave	Watts	Volts	Amp.	Aper.	Lum.	Temp.	Luz	Precio
A70LED17/LD	17 W	85/145V	0.133	360°	1200	6500°K	LD	\$35.00

Acabado:
Cuerpo de aluminio y PVC blanco
Difusor de acrílico opalino.



Bajo precio

NUEVO



TIPO A-60 REGULABLE 3 TONOS DE INTENSIDAD



Clave

- Watts
- Volts
- Amp.
- Aper.
- Lum.
- Temp.
- S Precio

A603DIM9/LD	9W	127V	0.118	360°	820	Regulable	\$40.00
-------------	----	------	-------	------	-----	-----------	---------

Acabado:
Cuerpo de aluminio y PVC blanco
Difusor de acrílico opalino.



NUEVO



TIPO A-60 LED 3 TONOS DE COLOR



Clave

- Watts
- Volts
- Amp.
- Aper.
- Lum.
- Temp.
- S Precio

A603CCT9	9W	127V	0.118	360°	820	Regulable	\$39.00
----------	----	------	-------	------	-----	-----------	---------

Acabado:
Cuerpo de aluminio y PVC blanco
Difusor de acrílico opalino.



A65F LED con fotocelda integrada

FOTOCELDA AUTOMÁTICA



Clave

- Watts
- Volts
- Amp.
- Aper.
- Lum.
- Temp.
- Luz
- S Precio

A65FC12/LD	12 W	127V	0.19	270°	1000	6500°K	LD	\$110.00
------------	------	------	------	------	------	--------	----	----------

Acabado:
Cuerpo de aluminio y PVC blanco
Difusor de acrílico opalino.



A60 LED con sensor de movimiento y sensor de día

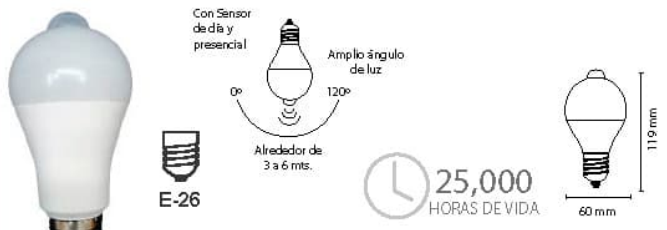

Clave

- Watts
- Volts
- Amp.
- Aper.
- Lum.
- Temp.
- Luz
- S Precio

A60SEN9/LD	9W	85/265V	0.071	120°	900	6500°K	LD	\$100.00
------------	----	---------	-------	------	-----	--------	----	----------

Acabado:
Cubierta y difusor de acrílico opalino



A55 LED Repelente



Clave

- Watts
- Volts
- Amp.
- Aper.
- Temp.
- Luz
- S Precio

A55LED7/RE	7W	127V	0.005	270°	1700°K	Repelente	\$65.00
------------	----	------	-------	------	--------	-----------	---------

Acabado:
Cubierta de aluminio y PVC amarillo
Difusor de acrílico opalino amarillo



A60 LED BLB Luz Negra



Clave

- Watts
- Volts
- Amp.
- Aper.
- Luz
- S Precio

A60LED6/BLB	6 W	100/240V	0.04	360°	Negra	\$90.00
-------------	-----	----------	------	------	-------	---------

Acabado:
Cuerpo de aluminio y PVC blanco
Difusor de acrílico opalino azul

Nota:
Longitud de onda 400nm



LÁMPARAS LED

A60 LED con sombra CIRCULAR LED



E-26

25,000
HORAS DE VIDA

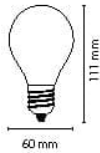

Clave	Watts	Volts	Amp.	Aper.	Lum.	Temp.	Luz	Precio
A60LED8CO/LD	8W	127V	0.062	200°	800	6500°K	LD	\$60.00

Acabado:
Cubierta y difusor de acrílico opalino



Ilumina tus espacios

A80 LED con celda solar



Recargable mediante
luz solar y electricidad

E-27

35,000
HORAS DE VIDA

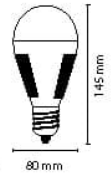

Clave	Watts	Volts	Amp.	Aper.	Lum.	Temp.	Luz	Precio
A80LED125OL	12W	85/265V	0.094	270°	700	6500°K	LD	\$150.00

Acabado:
Cubierta plástica y difusor de acrílico opalino
Incluye:
Un soquet portatil con gancho



LÁMPARA LED CIRCULAR para enroscar o sobreponer



Base E-26 desmontable

E-26

25,000
HORAS DE VIDA

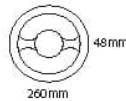

Enciende luz interior y exterior



Clave	Watts	Volts	Amp.	Aper.	Lumen	Temp.	Luz	Med. (axb/mm)	Precio
C22LED/LD	22W	85/254V	0.5	180°	1800	6500°K	LD	260x48	\$196.00

*Nota: La base E-26 se
desmonta para hacer la
lampara de sobreponer

Acabado:
Cuerpo de aluminio y PVC blanco



A60SMD LED Multicolor

NUEVO



E-26

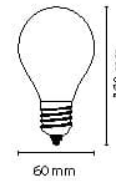

35,000
HORAS DE VIDA



Clave	Watts	Volts	Amp.	Aper.	Lum.	Luz	Precio
A60SMD/COL	2W	127V	0.39	360°	3301	Color	\$53.00



Circular LED



CIR12



CIR18



CIR24



CIR36

Acabado:
Cuerpo de aluminio y PVC blanco
Difusor de acrílico opalino

26



Clave	Watts	Volts	Amp.	Aper.	Lum.	Temp.	Luz	Emp.	Precio
CIR12	12W	100/220V	0.009	180°	1080	6400°K	LD	60/5	\$98.00
CIR18	18W	100/220V	0.014	180°	1620	6400°K	LD	30/5	\$145.00
CIR24	24W	100/220V	0.018	180°	1920	6400°K	LD	30/5	\$185.00
CIR36	36W	100/220V	0.018	180°	3240	6400°K	LD	30/5	\$245.00

E-26

25,000
HORAS DE VIDA

Bajo precio

MINI BALA LED

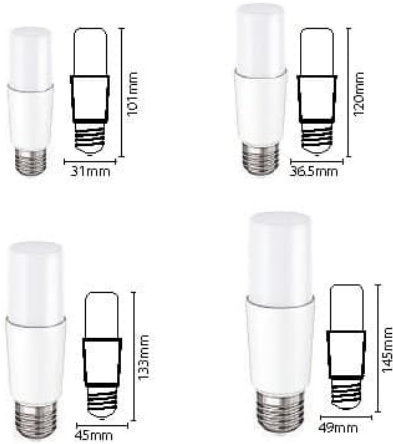

Acabado:
Cuerpo de aluminio y PVC blanco
Difusor de acrílico opalino

Clave	Watts	Volts	Amp.	Aper.	Lum.	Temp.	Luz	Precio
T30LED7/LD	7W	100/240V	0.005	360°	600	6500°K	LD	\$33.00
T37LED9/LD	9W	100/240V	0.007	360°	650	6500°K	LD	\$36.00
T45LED12/LD	12W	100/240V	0.009	360°	1000	6500°K	LD	\$46.00
T50LED15/LD	15W	100/240V	0.011	360°	1250	6500°K	LD	\$51.00



TIPO BALA LED



Acabado:
Cuerpo de aluminio y PVC blanco
Difusor de acrílico opalino



Clave	Watts	Volts	Amp.	Aper.	Lum.	Temp.	Luz	Emp.	Precio
T100LED30/LD	30W	100/240V	0.236	360°	3000	6500°K	LD	24/3	\$113.00
T120LED40/LD	40W	100/240V	0.314	360°	4000	6500°K	LD	24/3	\$130.00
T140LED50/LD	50W	100/240V	0.393	360°	5000	6500°K	LD	20/2	\$200.00

TIPO CANDIL LED



Clave	Watts	Volts	Amp.	Lum.	Temp.	Aper.	Luz	Precio
T44LED/BC	2.5W	127V	0.019	200	2700°K	120°	BC	\$125.00
T44LED/LD	2.5W	127V	0.019	200	6500°K	120°	LD	\$125.00

Acabado:
Difusor de plástico transparente



3U LED



Clave	Watts	Volts	Aper.	Lum.	Temp.	Luz	Med. (axb/mm)	Precio
3U75MD/LD	7 W	85/265V	360°	630	6500°K	LD	112x43	\$27.00
3U115MD/LD	11 W	85/265V	360°	990	6500°K	LD	142x43	\$30.00

Acabado:
Cuerpo de aluminio y PVC blanco
Difusor de cristal transparente



Bajo precio

LÁMPARAS LED

Ilumina tus espacios

4U LED

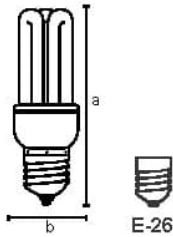

Clave

Clave	Watts	Volts	Aper.	Lum.	Temp.	Luz	Med. [axb/mm]	Emp.	Precio
4U18SMD/LD	18W	85/265V	360°	1620	6500°K	LD	178x59	100/10	\$48.00 ✓
4U26SMD/LD	26W	85/265V	360°	2340	6500°K	LD	260x70	50/10	\$94.00 ✓
4U42SMD/LD	42W	85/265V	360°	3780	6500°K	LD	272x81	50/10	\$115.00 ✓

Acabado:

Cuerpo de aluminio y PVC blanco
Difusor de cristal transparente

35,000 HORAS DE VIDA

ESPIRAL LED

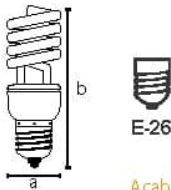

35,000 HORAS DE VIDA

Acabado:

Cuerpo de aluminio y PVC blanco
Difusor de cristal transparente

Clave	Watts	Volts	Aper.	Lum.	Temp.	Luz	Med. [axb/mm]	Emp.	Precio
ES9SMD/LD	9 W	85/265V	360°	810	6500°K	LD	120x43	100/10	\$35.00 ✓
ES14SMD/BC	14 W	85/265V	360°	1260	3000°K	BC	155x60	100/10	\$42.00 ✓
ES14SMD/LD	14 W	85/265V	360°	1260	6500°K	LD	155x60	100/10	\$42.00 ✓
ES23SMD/BC	23 W	85/265V	360°	2070	3000°K	BC	165x60	100/10	\$49.00 ✓
ES23SMD/LD	23 W	85/265V	360°	2070	6500°K	LD	165x60	100/10	\$49.00 ✓
ES34SMD/LD	34 W	85/265V	360°	3060	6500°K	LD	205x83	50/10	\$120.00

A60 Filamento LED 4W

NUEVO

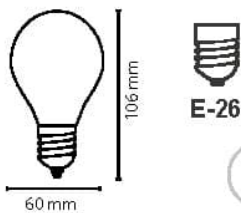

35,000 HORAS DE VIDA



Clave

Clave	Watts	Volts	Amp.	Aper.	Lum.	Temp.	Luz	Precio
A60FILED4/BC	4W	127V	0.031	360°	460	2700°K	BC	\$35.00 ✓
NUEVO A60FILED4/LD	4W	127V	0.440	360°	460	6500°K	LD	\$35.00

Acabado:

Difusor de cristal transparente

100/10

A60 Filamento LED 8W

NUEVO

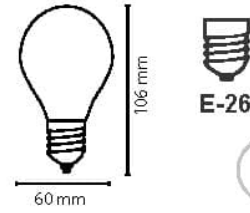

35,000 HORAS DE VIDA



Clave

Clave	Watts	Volts	Amp.	Aper.	Lum.	Temp.	Luz	Precio
A60FILED8/BC	8W	127V	0.062	360°	820	2700°K	BC	\$42.00 ✓
NUEVO A60FILED8/LD	8W	127V	0.880	360°	920	6500°K	LD	\$42.00

Acabado:

Difusor de cristal transparente

100/10

A60DIM
Filamento Dimeable



E-26



10,000 HORAS DE VIDA



Clave	Watts	Volts	Amp.	Aper.	Lum.	Temp.	Luz	Precio
A60DIM4/BC	4W	127V	0.031	360°	500	3000°K	BC	\$30.00
A60DIM4/LD	4W	127V	0.031	360°	500	6500°K	LD	\$30.00

Acabado:
Difusor de policarbonato



ST64 TIPO PERA Filamento LED



E-26

35,000 HORAS DE VIDA

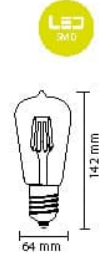

Clave	Watts	Volts	Amp.	Aper.	Lum.	Temp.	Luz	Precio
ST64FILED8/BC	8W	127V	0.062	360°	820	2700°K	BC	\$65.00

Acabado:
Difusor de cristal transparente



S14 Filamento LED

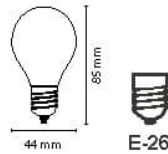

10,000 HORAS DE VIDA



Clave	Watts	Volts	Amp.	Aper.	Lum.	Temp.	Luz	Precio
S14LED/CL	1W	127V	0.009	360°	70	2700°K	BC	\$18.00
S14LED/VE	1W	127V	0.009	360°	30	-	VERDE	\$18.00
S14LED/RO	1W	127V	0.009	360°	30	-	ROJO	\$18.00
S14LED/AM	1W	127V	0.009	360°	30	-	AMARILLO	\$18.00
S14LED/AZ	1W	127V	0.009	360°	30	-	AZUL	\$18.00

NUEVO
Mayor intensidad de color con el filamento LED de color.

Acabado:
Difusor de policarbonato



VELA Filamento LED



E-12

E-14

E-26

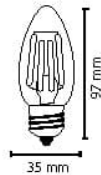

35,000 HORAS DE VIDA



Clave	Watts	Volts	Amp.	Lum.	Base	Temp.	Aper.	Luz	Precio
VEFILED4E12/BC	4 W	127V	0.031	460	E12	2700°K	360°	BC	\$33.00
VEFILED4E12/LD	4 W	127V	0.031	460	E12	6400°K	360°	LD	\$33.00
VEFILED4E14/BC	4 W	127V	0.031	460	E14	2700°K	360°	BC	\$33.00
VEFILED4E14/LD	4 W	127V	0.031	460	E14	6400°K	360°	LD	\$33.00
VEFILED4E26/BC	4 W	127V	0.031	460	E26	2700°K	360°	BC	\$33.00
VEFILED4E26/LD	4 W	127V	0.031	460	E26	6400°K	360°	LD	\$33.00

Acabado:
Difusor de cristal transparente



Bajo precio



LÁMPARAS LED

Ilumina tus espacios

NUEVO

VELA Filamento Dimeable



E-12

E-14

E-26

10,000 HORAS DE VIDA



Clave	Watts	Volts	Amp.	Aper.	Lum.	Base	Temp.	Luz	Precio
VEDIM4E12/BC	4 W	127V	0.031	360°	500	E12	3000°K	BC	\$38.00 ✓
VEDIM4E12/LD	4 W	127V	0.031	360°	500	E12	6500°K	LD	\$38.00 ✓
VEDIM4E14/BC	4 W	127V	0.031	360°	500	E14	3000°K	BC	\$38.00 ✓
VEDIM4E14/LD	4 W	127V	0.031	360°	500	E14	6500°K	LD	\$38.00 ✓
VEDIM4E26/BC	4 W	127V	0.031	360°	500	E26	3000°K	BC	\$38.00 ✓
VEDIM4E26/LD	4 W	127V	0.031	360°	500	E26	6500°K	LD	\$38.00 ✓

Acabado:

Difusor de policarbonato

100/10

FLAMA Filamento FL4

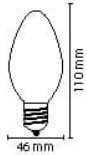

E-26

10,000 HORAS DE VIDA



Clave	Watts	Volts	Amp.	Aper.	Lum.	Base	Temp.	Luz	Precio
FL4FILED/BC	4 W	127V	0.06	360°	460	E26	2700°K	BC	\$39.00 ✓
FL4FILED/LD	4 W	127V	0.06	360°	460	E26	6400°K	LD	\$39.00 ✓

Acabado:

Difusor de cristal transparente

100/10

BALA LED Luz Fuego



E-26

25,000 HORAS DE VIDA

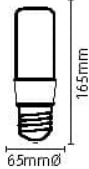

Clave	Watts	Volts	Amp.	Aper.	Temp.	Luz	Precio
FFT65LED	2W	127V	0.032	270°	1500°K	BC	\$99.00 ✓

Acabado:

PBT Aluminio con recubrimiento en PC color naranja

50/10

TUBULAR AJUSTABLE LED

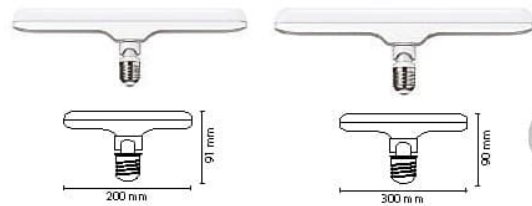

E-26

25,000 HORAS DE VIDA



Clave	Watts	Volts	Amp.	Aper.	Lum.	Temp.	Luz	Emp.	Precio
T200LED12/LD	12W	100/240V	0.009	200°	1200	6500°K	LD	100/10	\$60.00
T300LED18/LD	18W	100/240V	0.014	200°	1800	6500°K	LD	50/5	\$86.00



Acabado:

Cuerpo de aluminio y PVC blanco
Difusor de acrílico opalino

✓ Bajo precio



OVAL LED



Clave	Watts	Volts	Amp.	Aper. Lum.	Temp.	Luz	Emp.	Precio
ED90LED40/LD	40W	100/240V	0.031	360°	4100	6500°K	LD 24/3	\$300.00
ED120LED70/LD	70W	100/240V	0.055	360°	7100	6500°K	LD 12/3	\$520.00

Acabado:
Cuerpo de aluminio y PVC blanco
Difusor de acrílico opalino



TUBULAR TIPO VENTILADOR LED



Clave	Watts	Volts	Amp.	Aper. Lum.	Temp.	Luz	Med. [axb/mm]	Emp.	Precio
FAN26	26W	100/240V	0.204	360°	2100	6400°K	LD 52x234	50/5	\$160.00
FAN39	39W	100/240V	0.307	360°	3120	6400°K	LD 73x234	25/5	\$215.00
FAN52	52W	100/240V	0.409	360°	4160	6400°K	LD 90x234	25/5	\$275.00



Acabado:
Cuerpo de aluminio y PVC blanco
Difusor de acrílico opalino

T5 LED 56.3 cm

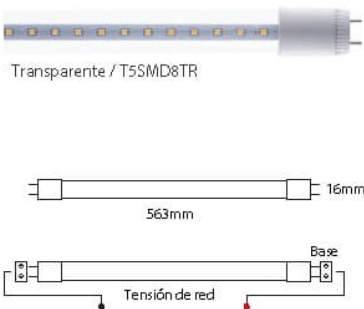

Acabado:
Difusor de acrílico
Disipador de calor de aluminio
Driver electrónico integrado

Clave	Watts	Volts	Amp.	Aper. Lum.	Temp.	Luz	Precio
T5SMD8TR/LD	8W	127V	0.062	330°	1200	6500°K	LD \$60.00
T5SMD8OP/LD	8W	127V	0.062	330°	1200	6500°K	LD \$60.00



Bajo precio

TUBOS LED

ilumina tus espacios

T5 LED 120 cm



Transparente / T5SMD14



Opalino / T5SMD14OP



Acabado:
Difusor de acrílico
Disipador de calor de aluminio
Driver electrónico integrado



Clave	Watts	Volts	Amp	Aper	Lumen	Temp	Luz	Precio
T5SMD14/LD	14W	100/130V	0.141	330°	1200	6500°K	LD	\$70.00 ✓
T5SMD14OP/LD	14W	127		330°	2400	6500°K	LD	\$70.00 ✓



T8 LED Cristal Transparente y opalino 60 cm



Transparente / T8SMD60CC



Opalino / T8SMD60F

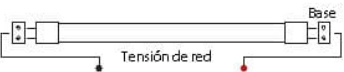

Acabado:
Difusor de cristal transparente
Driver electrónico integrado



Clave	Watts	Volts	Amp	Aper	Lum	Temp	Luz	Precio
T8 SMD60CC/BC	9W	85/145V	0.070	330°	800	2700°K	BC	\$39.00 ✓
T8 SMD60CC/LD	9W	85/145V	0.070	360°	800	6500°K	LD	\$39.00 ✓
T8 SMD60F/LD	9W	90/265V	0.070	360°	800	6500°K	LD	\$39.00 ✓



T8 LED Cristal Transparente y Opalino 120 cm



Transparente / T8SMD18CC



Opalino / T8SMD18OP

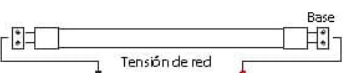

Acabado:
Difusor de cristal
Driver electrónico integrado



Clave	Watts	Volts	Amp	Aper	Lum	Temp	Luz	Precio
T8SMD18CC/BC	18W	85/265V	0.141	330°	1500	2700°K	BC	\$43.00 ✓
T8SMD18CC/LD	18W	85/265V	0.141	330°	1176	6400°K	LD	\$43.00 ✓
T8SMD18OP/LD	18W	85/265V		330°	1600	6500°K	LD	\$43.00 ✓



T8 LED Cristal de Colores 120 cm



Acabado:
Difusor de cristal transparente
Driver electrónico integrado



Clave	Watts	Volts	Aper	Luz	Precio
T8SMD/RO	18W	85/265V	330°	Rojo	\$90.00 ✓
T8SMD/AZ	18W	85/265V	330°	Azul	\$90.00 ✓
T8SMD/VE	18W	85/265V	330°	Verde	\$90.00 ✓
T8SMD/AM	18W	85/265V	330°	Amarillo	\$90.00 ✓
T8SMD/MO	18W	85/265V	330°	Morado	\$90.00 ✓



✓ Bajo precio



T8 LED Slim FA8 Transparente y Opalino 120cm



Transparente / T8SMD120CFA8



Opalino / T8SMDCF8OP



50,000 HORAS DE VIDA

Acabado:
Difusor de cristal transparente



Clave	Watts	Volts	Amp.	Aper.	Lum.	Temp.	Luz	Precio
T8SMD120CFA8/LD	18W	85/265V	0.141	110°	1500	6500°K	LD	\$70.00
T8SMDCF8OP/LD	18W	85/265V	0.141	110°	1500	6500°K	LD	\$70.00



T8 LED Slim FA8 Transparente 240cm



50,000 HORAS DE VIDA

Acabado:
Difusor de cristal transparente



Clave	Watts	Volts	Amp.	Aper.	Lum.	Temp.	Luz	Precio
T8SMD240CFA8/LD	36W	85/265V	0.283	110°	3000	6500°K	LD	\$210.00



LÁMPARA CIRCULAR LED Base Magnética

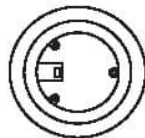

215mm

50,000 HORAS DE VIDA

Acabado:
Difusor de acrílico
Driver electrónico integrado

Nota:
Base magnética, No requiere herramientas para su colocación en superficies metálicas



Clave	Watts	Volts	Amp.	Aper.	Lum.	Temp.	Luz	Precio
CLED20/LD	20W	127V	0.157	180°	1800	6500°K	LD	\$99.00



✓ Bajo precio



LUMINARIOS DE LED
INTERIOR – EXTERIOR
Y DE EMERGENCIA

LUMINARIO CON REJILLA con 2 tiras LED



80,000 HORAS DE VIDA

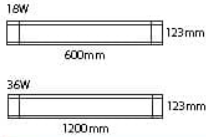

Acabado:
Base reflectora de lámina de acero blanca
Rejillas de acrílico platinado cromo
2 tapas laterales de PVC blancas



Clave	Watts	Volts	Amp.	Aper.	Lumen	Temp.	Luz	Precio
LULED2X9R	18W	85/265V	0.141	120°	1400	6500°K	LD	\$210.00
LULED2X18R	36W	85/145V	0.45	120°	2800	6500°K	LD	\$270.00

Incluye:
• 2 módulos lineales LED
• Driver electrónico integrado



LUMINARIO LED Tipo barra / cubierta opalina



80,000 HORAS DE VIDA

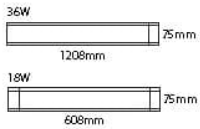

Acabado:
Base reflectora de lámina de acero blanca
Difusor de acrílico opalino
2 tapas laterales de PVC blancas



Clave	Watts	Volts	Amp.	Aper.	Lumen	Temp.	Luz	Precio
TAO18LED	18W	85/265V	0.141	120°	1400	6500°K	LD	\$95.00
TAO36LED	36W	85/265V	0.283	120°	2800	6500°K	LD	\$149.00

Incluye:
• 2 módulos lineales LED
• Driver electrónico integrado
• 2 grapas de sujeción



LUMINARIO LED LINEAL para uso Interior



50,000 HORAS DE VIDA



Acabado:
Base reflectora de lámina de acero blanca
Difusor de acrílico opalino
2 tapas laterales de PVC blancas



Clave	Watts	Volts	Amp.	Aper.	Lumen	Temp.	Luz	Precio
REKS4LED/LD	54W	85/265V	0.34	120°	3600	6500°K	LD	\$340.00

Incluye:
• 2 módulos lineales LED
• Driver electrónico integrado
• 2 grapas de sujeción



LUMINARIO LED ULTRADELGADO



80,000 HORAS DE VIDA

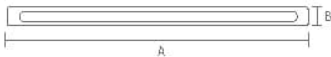

Acabado:
Cuerpo de aluminio color blanco
Difusor de acrílico semi opalino



Clave	Watts	Volts	Amp.	Aper.	Lumen	Temp.	Luz	Med. (aob/mm)	Precio
SKIN5/BC	5W	127V	0.039	105°	425	3000°K	BC	284x23	\$98.00
SKIN5/LD	5W	127V	0.039	105°	425	6500°K	LD	284x23	\$98.00
SKIN9/BC	9W	127V	0.070	105°	765	3000°K	BC	584x23	\$125.00
SKIN9/LD	9W	127V	0.070	105°	765	6500°K	LD	584x23	\$125.00
SKIN14/BC	14W	127V	0.110	105°	1190	3000°K	BC	884x23	\$165.00
SKIN14/LD	14W	127V	0.110	105°	1190	6500°K	LD	884x23	\$165.00
SKIN18/BC	18W	127V	0.141	105°	1530	3000°K	BC	1184x23	\$192.00
SKIN18/LD	18W	127V	0.141	105°	1530	6500°K	LD	1184x23	\$192.00



Bajo precio

MINI LÁMPARAS LED INTERCONECTABLES

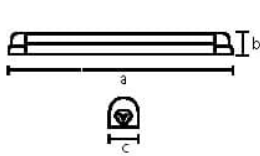

80,000 HORAS DE VIDA

Acabado:
Cuerpo de plástico.
Difusor de acrílico opalino

*NOTA: El modelo TL36 viene con cuerpo de aluminio
Accesorios incluidos

Clave	Watts	Volts	Amp.	Apertura	Lumen	Temp.	Luz	Med. [axb/mm]	Emp.	Precio
TL5LED/LD	5W	127V	0.039	120°	500	6400°K	LD	288x23x34	25/10	\$74.00
TL9LED/BC	9W	127V	0.070	120°	860	3000°K	BC	568x23x24	30/10	\$90.00
TL9LED/LD	9W	127V	0.070	120°	860	6400°K	LD	568x23x24	30/10	\$90.00
TL14LED/LD	14W	127V	0.110	120°	1100	6400°K	LD	868x23x24	25/10	\$99.00
TL18LED/BC	18W	127V	0.141	120°	1530	3000°K	BC	1200x40x22	30/10	\$120.00
TL18LED/LD	18W	127V	0.141	120°	1530	6400°K	LD	1200x40x22	30/10	\$120.00
TL36LED/LD	36W	127V	0.283	120°	3000	6400°K	LD	2400x40x22	25/10	\$260.00
TL3CON	Conec. Flex. de 3 Línea, 10 cm. de cable								100/20	\$13.20

MINI LÁMPARAS LED INTERCONECTABLES DE COLORES

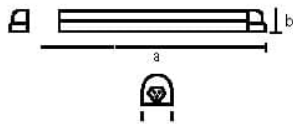

80,000 HORAS DE VIDA

Acabado:
Cuerpo de plástico
Difusor de acrílico opalino
Accesorios incluidos

Clave	Watts	Volts	Amp.	Luz	Med. [axb/mm]	Precio
TL18LED/RO	18W	85/145V	0.4	Rojo	1178x23x34	\$110.00
TL18LED/AZ	18W	85/145V	0.4	Azul	1178x23x34	\$110.00
TL18LED/NE	18W	85/145V	0.4	Verde	1178x23x34	\$110.00
TL18LED/AM	18W	85/145V	0.4	Amarillo	1178x23x34	\$110.00
TL18LED/MO	18W	85/145V	0.4	Morado	1178x23x34	\$110.00

Colores:



30/5

LUMINARIO LED TIPO CORCHOLATA para sobreponer y empotrar



Sobreponer



Empotrar

50,000 HORAS DE VIDA

Acabado:
Cuerpo de lámina de acero inoxidable color satin.
Difusor de acrílico semi opalino

Incluye:
• Driver electrónico integrado
• 2 piezas, 1 luminario de empotrar y una cubierta de sobreponer

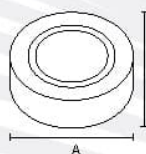

Clave	Watts	Volts	Amp.	Aper.	Lumen	Temp.	Luz	Precio
EM3LED/SA	3W	85/265V	0.023	120°	270	6400°K	LD	\$160.00

10/3

36

Bajo precio

LUMINARIO LED para empotrar en plafón

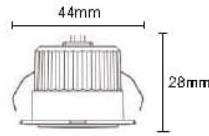

Acabado:
Cuerpo de plástico

35,000 HORAS DE VIDA

Clave	Watts	Volts	Amp.	Aper.	Lumen	Temp.	Luz	Emp.	Precio
EMR11LED/BC	3W	85/265V	0.02	38°	240	2700°K	BC	100/5	\$45.00
EMR11LED/LD	3W	85/265V	0.02	38°	240	6500°K	LD	100/5	\$45.00

LUMINARIO LED DIRIGIBLE para empotrar en bote o plafón

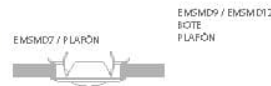

20,000 HORAS DE VIDA

Acabado:
Cuerpo de polímero plástico blanco
Difusor de acrílico transparente

Incluye:
• Driver electrónico electrónico

Clave	Watts	Volts	Amp.	Lum.	Temp.	Luz	Med. (axb/mm)	Precio
EMSMD7/BC	7W	90/265V	0.09	600	3000°K	BC	90x30	\$49.00
EMSMD7/LD	7W	90/265V	0.09	600	6500°K	LD	90x30	\$49.00
EMSMD9/BC	9W	90/265V	0.09	750	3000°K	BC	113x40	\$59.00
EMSMD9/LD	9W	90/265V	0.09	750	6500°K	LD	113x40	\$59.00
EMSMD12/BC	12W	90/265V	0.09	1000	3000°K	BC	133x45	\$85.00
EMSMD12/LD	12W	90/265V	0.09	1000	6500°K	LD	133x45	\$85.00

100/5

LUMINARIO LED DIRIGIBLE para empotrar en plafón



Ultradelgado
Hasta 90% de Ahorro

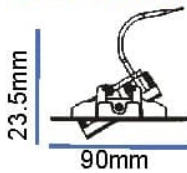

Acabado:
Cuerpo de plástico

25,000 HORAS DE VIDA

Clave	Watts	Volts	Amp.	Aper.	Lumen	Temp.	Luz	Emp.	Precio
EM7DIR/BC	7W	85-265V	0.09	38°	650	3000°K	BC	100/20	\$49.00
EM7DIR/LD	7W	85-265V	0.09	38°	650	6500°K	LD	100/20	\$49.00

LUMINARIO LED DIRIGIBLE DE ALUMINIO para empotrar en plafón



50,000 HORAS DE VIDA

Acabado:
Cuerpo de aluminio
Difusor de lentillas acrílicas transparentes
Incluye:
• Driver electrónico remoto

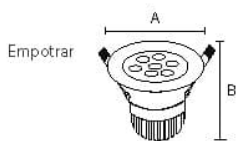

Clave	Watts	Volts	Amp.	Aper.	Lumen	Temp.	Luz	Med. (axb/mm)	Empaque	Precio
ALUX3/BC	3 W	110/240V	0.023	120°	300	3000°K	BC	88x48	50/5	\$98.00
ALUX3/LD	3 W	110/240V	0.023	120°	300	6400°K	LD	88x48	50/5	\$98.00
ALUX7/BC	7 W	110/240V	0.055	120°	700	3000°K	BC	110x78	40/5	\$168.00
ALUX7/LD	7 W	110/240V	0.055	120°	700	6400°K	LD	110x78	40/5	\$168.00
ALUX12/BC	12 W	110/240V	0.094	120°	1200	3200°K	BC	138x65	24/5	\$245.00
ALUX12/LD	12 W	110/240V	0.094	120°	1200	6400°K	LD	138x65	24/5	\$245.00

Bajo precio

PANEL CIRCULAR LED para empotrar



Acabado:
Cubierta de plástico,
base de aluminio
Difusor antibrillo

20,000
HORAS DE VIDA

Clave	Watts	Volts	Amp.	Apertura	Lumen	Temp.	Luz	Med. [axb/mm]	Empaque	Precio
MP7/BC	7W	85/265V	0.11	140°	480	3000°K	BC	120 x 20	40/10	\$55.00
MP7/LD	7W	85/265V	0.11	140°	480	6500°K	LD	120 x 20	40/10	\$55.00
MP10/BC	10W	85/265V	0.15	140°	720	3000°K	BC	146 x 20	30/10	\$68.00
MP10/LD	10W	85/265V	0.15	140°	720	6500°K	LD	146 x 20	30/10	\$68.00
MP12/LD	12W	127/265V	0.20	140°	900	6500°K	LD	170 x 20	30/10	\$74.00
MP20/LD	20W	127/265V	0.32	140°	1440	6500°K	LD	225 x 20	20/10	\$94.00



PANEL LED CIRCULAR para empotrar - AJUSTABLE



Acabado:
Cuerpo de aluminio blanco
Difusor de acrílico opalino

NUEVO Sistema Ajustable

35,000
HORAS DE VIDA

Clave	Watts	Volts	Amp.	Apertura	Lumen	Temp.	Luz	Med. [axb/mm]	Empaque	Precio
SKY7PL/BC	7 W	85/265V	0.11	105°	480	3000°K	BC	100x80	100/5	\$62.00
SKY7PL/LD	7 W	85/265V	0.11	105°	480	6500°K	LD	100x80	100/5	\$62.00
SKY10PL/BC	10 W	85/265V	0.078	105°	720	3000°K	BC	115x80	100/5	\$70.00
SKY10PL/LD	10 W	85/265V	0.078	105°	720	6500°K	LD	115x80	100/5	\$70.00
SKY15PL/BC	15 W	85/265V	0.26	105°	800	3000°K	BC	173x80	60/5	\$89.00
SKY15PL/LD	15W	85/265V	0.26	105°	800	6500°K	LD	172x90	60/5	\$89.00
SKY20PL/BC	20 W	85/265V	0.157	105°	1440	3000°K	BC	225x80	20/5	\$124.00
SKY20PL/LD	20 W	85/265V	0.157	105°	1440	6500°K	LD	225x80	20/5	\$124.00



PANEL LED CIRCULAR para sobreponer



Acabado:
Cuerpo de aluminio blanco
Difusor de acrílico opalino

35,000
HORAS DE VIDA

Clave	Watts	Volts	Amp.	Aper.	Lumen	Temp.	Luz	Med. [axb/mm]	Emp.	Precio
SOLE8/BC	8W	85/265V	0.13	105°	640	3000°K	BC	115x32	50/5	\$78.00
SOLE8/LD	8W	85/265V	0.13	105°	640	6500°K	LD	115x32	50/5	\$78.00
SOLE12/BC	12W	127/265V	0.20	105°	900	3000°K	BC	170x32	30/5	\$89.00
SOLE12/LD	12W	127/265V	0.20	105°	900	6500°K	LD	160x26	30/5	\$89.00
SOLE18/BC	18W	127/265V	0.30	105°	1350	6500°K	BC	220x32	20/5	\$145.00
SOLE18/LD	18W	127/265V	0.30	105°	1350	3000°K	LD	220x28	20/5	\$145.00



PANEL LED CIRCULAR de Sobreponer con BASE E-26



Acabado:
Cuerpo de aluminio
Difusor de acrílico opalino

35,000
HORAS DE VIDA

Clave	Watts	Volts	Amp.	Apertura	Lumen	Temp.	Luz	Precio
BOWL	12W	100/240V	0.09	120°	880	6500°K	LD	\$238.00

20/2



Bajo precio

ARBOTANTE LED de sobreponer



Clave	Watts	Volts	Amp.	Aper.	Lumen	Temp.	Luz	Precio
AR15LED	15W	85/265V	0.118	120°	1100	6500°K	LD	\$130.00
ARRE15LED	15W	85/265V	0.118	120°	1100	6500°K	LD	\$130.00



PANEL LED CUADRADO para empotrar - AJUSTABLE

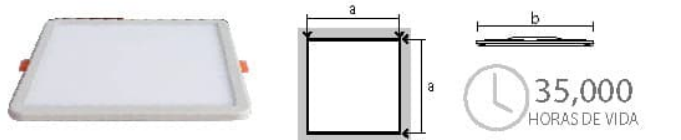

Clave	Watts	Volts	Amp.	Aper.	Lumen	Temp.	Luz	Med. (acab./mm)	Emp.	Precio
CUAD20/LD	20 W	127/254V	0.157	105°	1400	6500°K	LD	225x12	20/5	\$119.00

Acabado:
Cuerpo de aluminio blanco
Difusor de acrílico opalino



PANEL LED CUADRADO PLANO

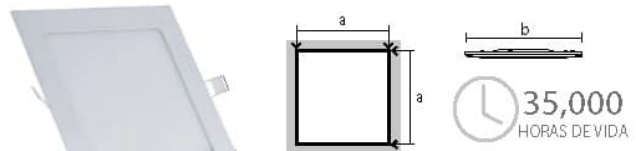

Clave	Watts	Volts	Amp.	Aper.	Lumen	Temp.	Luz	Med. (acab./mm)	Emp.	Precio
CUAD7/LD	7W	127/254V	0.055	105°	300	6500°K	LD	100x100	100/5	\$70.00

Acabado:
Cuerpo de aluminio blanco
Difusor de acrílico opalino

PANEL LED CUADRADO para sobreponer



Clave	Watts	Volts	Amp.	Aper.	Lumen	Temp.	Luz	Med. (acab./mm)	Emp.	Precio
CUT12/LD	12W	127/265V	0.20	105°	900	6500°K	LD	170x32	30/5	\$125.00
CUT18/LD	18W	127/265V	0.30	105°	1350	6500°K	LD	220x32	20/5	\$165.00
CUT24/LD	24W	127/265V	0.32	105°	1800	6500°K	LD	300x32	20/5	\$249.00

Acabado:
Cuerpo de aluminio blanco
Difusor de acrílico opalino



LUMINARIOS LED DECORATIVOS DIRIGIBLES Mini-Canope de Aluminio

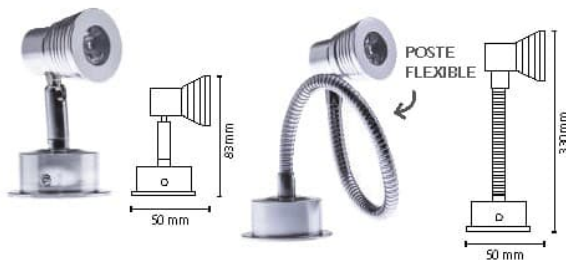

Clave	Watts	Volts	Amp.	Aper.	Lum.	Temp.	Luz	Precio
FAROLED	1W	100/230V	0.007	60°	100	6400°K	LD	\$180.00
FAROLEDPL	3W	100/230V	0.023	60°	270	6400°K	LD	\$205.00



Acabado:
Cuerpo de aluminio
Difusor de acrílico transparente

Incluye:
• Driver electrónico integrado



Bajo precio

LUMINARIO LED SUBURBANO 15W con fotocelda



Acabado:
Cuerpo de polímero plástico blanco
Difusor de acrílico facetado transparente

50,000 HORAS DE VIDA

Incluye:
• Driver electrónico integrado
• Una fotocelda
• Una entrada para el cable de alimentación IP65

Clave

Clave	Watts	Volts	Amp.	Aper.	Lum.	Temp.	Luz	Precio
SUB15LED	15W	85/240V	0.30	180°	1400	6400°K	LD	\$570.00



LUMINARIO LED SUBURBANO 20W con fotocelda



Acabado:
Cuerpo de polímero plástico blanco
Difusor de acrílico facetado transparente

50,000 HORAS DE VIDA

Incluye:
• Driver electrónico integrado
• Una fotocelda
• Una entrada para el cable de alimentación IP65

Clave

Clave	Watts	Volts	Amp.	Aper.	Lum.	Temp.	Luz	Precio
SUB20LED	20W	127V	0.157	180°	1600	6400°K	LD	\$830.00



LUMINARIO LED SUBURBANO 30W con fotocelda



Acabado:
Cuerpo de polímero plástico blanco
Difusor de acrílico facetado transparente

50,000 HORAS DE VIDA

Incluye:
• Driver electrónico integrado
• Una fotocelda
• Una entrada para el cable de alimentación IP65

Clave

Clave	Watts	Volts	Amp.	Aper.	Lum.	Temp.	Luz	Precio
SUB30LED	30W	85/265V	0.253	180°	2600	6400°K	LD	\$840.00



ARBOTANTE LED con fotocelda para sobreponer

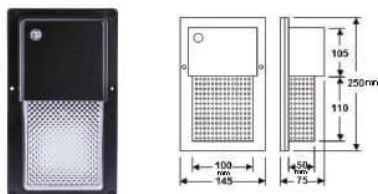

Acabado:
Cuerpo de PVC negro
Difusor de acrílico transparente facetado

50,000 HORAS DE VIDA

Clave

Clave	Watts	Volts	Amp.	Aper.	Lumen	Temp.	Luz	Emp.	Precio
WL10LED	10W	85/265V	0.24	180°	660	6400°K	LD	10/1	\$670.00



CAMPANAS LED DE ALUMINIO

CONVEX50 E26: 195mm height, 355mm diameter.

CONVEX100: 344mm height, 375mm diameter.

CONVEX150: 385mm height, 500mm diameter.

Acabado: Cuerpo y disipador de calor en aluminio. Difusor semiespecular de la campana. Difusor de la lámpara LED en acrílico opalino.

Incluye: Driver electrónico integrado. Anillo para su correcta suspensión.

35,000 HORAS DE VIDA

Clave	Watts	Volts	Amp	Aper.	Lumen	Temp.	Luz	Emp.	Precio
CONVEX50	50W	85/240V	0.393	180°	2200	6400°K	LD	4/1	\$550.00
CONVEX100	100W	85/240V	0.787	180°	7500	6400°K	LD	1	\$1,290.00
CONVEX150	150W	85/240V	1.141	180°	11250	6400°K	LD	1	\$1,770.00

LUMINARIO LED industrial y alumbrado público

PALED50: 143 mm diameter, 470 mm height.

PALED100: 173 mm diameter, 540 mm height.

Acabado: Aluminio y plástico.

50,000 HORAS DE VIDA

Clave	Watts	Volts	Amp	Aper.	Lumen	Temp.	Luz	Emp.	Precio
PALED50	50W	100/305V	0.393	120°	5000	6500°K	LD	10/3	\$1,050.00
PALED100	100W	100/305V	0.787	120°	10000	6500°K	LD	8/3	\$1,300.00

LUMINARIO LED INDUSTRIAL para uso exterior "UFO"

RILED150: 330 mm diameter, 135 mm height.

RILED200: 380 mm diameter, 135 mm height.

Acabado: Cuerpo de metal negro.

50,000 HORAS DE VIDA

Bajo precio

Clave	Watts	Volts	Amp	Aper.	Lumen	Temp.	Luz	Emp.	Precio
RILED150	150W	85/265V	1.18	60°	15000	6500°K	LD	1	\$1,900.00
RILED 200	200W	85/265V	1.57	60°	20000	6500°K	LD	1	\$2,600.00



REFLECTORES LED Ultradelgados



FLAT 10



FLAT 30



FLAT 50



FLAT COLORES



MULTICOLOR
INCLUYE CONTROL
REMOTO



FLAT 80



FLAT 100



FLAT 150



FLAT 200

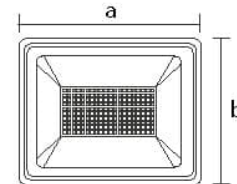

FLAT 10 / 30 / 50
80 / 100 / 150 / 200

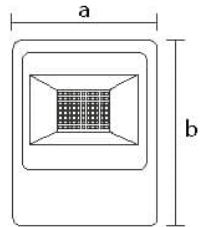

FLAT 50
COLORES

Producto Mejorado:

- Diseño más compacto y ultradelgado
- Sellado de alta calidad
- Nuevo sistema de enfriamiento

Acabado:

- Cuerpo de aluminio color negro
- Difusor de cristal transparente
- Reflector de aluminio semiespecular

Incluye:

- Driver electrónico integrado
- Empaque de silicona para un perfecto sellado
- horquilla basculante como base de sujeción
- Una entrada para toma de corriente IP65



Clave	Watts	Volts	Amp	Apertura	Lumen	Temp.	Luz	Med (axb/mm)	Empaque	Precio
FLAT 10/BC	10W	85/265V	0.07	130°	800	2700°K	BC	65X90X30	60/1	\$69.00
FLAT 10/LD	10W	85/265V	0.07	130°	800	6400°K	LD	65X90X30	60/1	\$69.00
FLAT 30/BC	30W	85/265V	0.23	130°	2400	2700°K	BC	100X133X30	40/1	\$139.00
FLAT 30/LD	30W	85/265V	0.23	130°	2400	6400°K	LD	100X133X30	40/1	\$139.00
FLAT 50/BC	50W	85/265V	0.39	130°	4000	2700°K	BC	135X168X30	30/1	\$200.00
FLAT 50/LD	50W	85/265V	0.39	130°	4000	6400°K	LD	135X168X30	30/1	\$200.00
FLAT 50/COL	50W	85/265V	0.39	130°	4000	-	Color	211X283X41	18/1	\$540.00
FLAT 80/LD	80W	85/265V	0.62	130°	5600	6400°K	LD	203X246X35	16/1	\$370.00
FLAT 100/BC	100W	85/265V	0.78	130°	8000	2700°K	BC	203X246X35	16/1	\$380.00
FLAT 100/LD	100W	85/265V	0.78	130°	8000	6400°K	LD	203X246X35	16/1	\$380.00
FLAT 150/LD	150W	85/265V	1.57	130°	12000	6400°K	LD	240X294X38	10/1	\$570.00
FLAT 200/LD	200W	85/265V	1.57	130°	12000	6400°K	LD	281x340x38	10/1	\$790.00

✓ Bajo precio

LUMINARIO LED PARA USO INTERIOR Y EXTERIOR

NUEVA LÍNEA DE ARBOTANTES
3 TONALIDADES DE LUZ
 En un mismo Luminario

NUEVO
 IP65
 SMD



1050

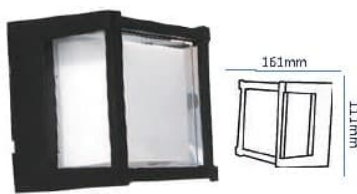
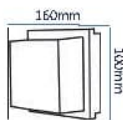

1054

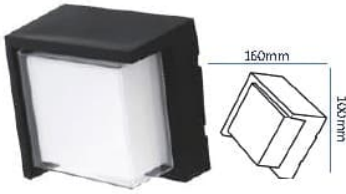
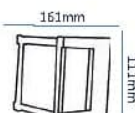

1052

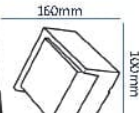

1056



1040

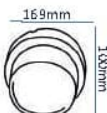

1044

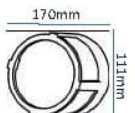

1042

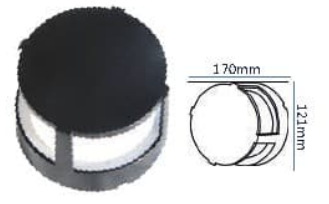
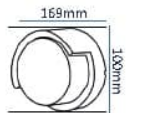

1046

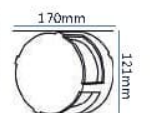

Clave	Watts	Volts	Amp.	Aper. Lum.	Temp.	Luz	Precio
1050	15W	127V	0.025	120°	1350	Regulable	\$280.00
1054	15W	127V	0.025	120°	1350	Regulable	\$280.00
1052	15W	127V	0.025	120°	1350	Regulable	\$280.00
1056	15W	127V	0.025	120°	1350	Regulable	\$285.00
1040	15W	127V	0.025	120°	1350	Regulable	\$280.00
1044	15W	127V	0.025	120°	1350	Regulable	\$280.00
1042	15W	127V	0.025	120°	1350	Regulable	\$280.00
1046	15W	127V	0.025	120°	1350	Regulable	\$285.00

BC **BN** **LD**
 3000°K 4000°K 6500°K
 3 tonos de luz en un mismo luminario



25,000 HORAS DE VIDA

Acabado:
 Cuerpo de polímero plástico negro
 Difusor de acrílico facetado opaco
Incluye:
 • Driver electrónico integrado



LUMINARIO LED PARA USO INTERIOR Y EXTERIOR

NUEVO
 IP65
 SMD

25,000 HORAS DE VIDA



1130 (Luz de día)

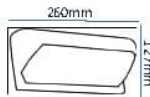

1135 (Blanco Cálido)

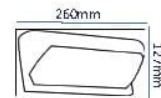

Clave	Watts	Volts	Amp.	Aper. Lum.	Temp.	Luz	Precio
1130	20W	127V	0.015	120°	1600	6500°K LD	\$275.00
1135	20W	127V	0.015	120°	1600	3000°K BC	\$275.00

Acabado:
 Cuerpo de polímero plástico negro
 Difusor de acrílico facetado opaco
Incluye:
 • Driver electrónico integrado

20/1

LUMINARIOS LED DE EXTERIOR

LUMINARIO LED PARA USO INTERIOR Y EXTERIOR

NUEVA LÍNEA DE ARBOTANTES
3 TONALIDADES DE LUZ
 En un mismo Luminario

NUEVO IP65 LED SMD

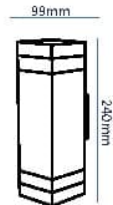
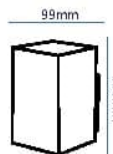
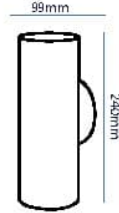
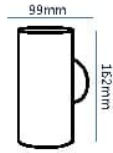

25,000 HORAS DE VIDA



3000°K 4000°K 6500°K
3 tonos de luz en un mismo luminario

SELECCIONA FÁCILMENTE LA LUZ DE LA LÁMPARA



CUENTA CON SELECTOR DE LUZ

Acabado:
 Cuerpo de polímero plástico negro
 Difusor de acrílico facetado opaco

Incluye:
 • Driver electrónico integrado

***Nota:**
 • Es de fácil instalación.
 • Temperatura de luz es regulable.



FÁCIL COLOCACIÓN

Clave	Watts	Volts	Amp.	Aper.	Lum.	Temp.	Color	Precio
1120	18W	127V	0,015	38°	1620	Regulable	Blanco	\$288.00
1125	18W	127V	0,015	38°	1620	Regulable	Negro	\$288.00
1140	18W	127V	0,015	38°	1620	Regulable	Blanco	\$320.00
1145	18W	127V	0,015	38°	1620	Regulable	Negro	\$320.00
1150	18W	127V	0,015	38°	1620	Regulable	Blanco	\$345.00
1155	18W	127V	0,015	38°	1620	Regulable	Negro	\$345.00
1160	18W	127V	0,015	38°	1620	Regulable	Blanco	\$305.00
1165	18W	127V	0,015	38°	1620	Regulable	Negro	\$305.00

20/5



LUMINARIO LED PARA USO INTERIOR Y EXTERIOR

NUEVA LÍNEA DE ARBOTANTES
3 TONALIDADES DE LUZ
En un mismo Luminario

NUEVO
IP65
LED SMD

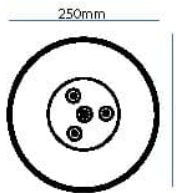

1240-1245

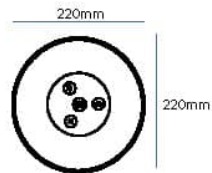

1230-1235

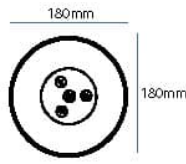

1220-1225

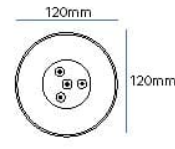

1210-1215



25,000 HORAS DE VIDA



3000°K 4000°K 6500°K
3 tonos de luz en un mismo luminario

SELECCIONA FÁCILMENTE LA LUZ DE LA LÁMPARA



CUENTA CON SELECTOR DE LUZ



FÁCIL COLOCACIÓN

Acabado:
Cuerpo de polímero plástico negro
Difusor de acrílico facetado opaco

Incluye:
• Driver electrónico integrado

***Nota:**
• Es de fácil instalación.
• Temperatura de luz es regulable.

Clave	Watts	Volts	Amp.	Aper.	Lumen	Temp.	Color	Precio
1210	10W	127V	0.015	120°	900	Regulable	Negro	\$208.00
1215	10W	127V	0.015	120°	900	Regulable	Blanco	\$208.00
1220	12W	127V	0.09	120°	1200	Regulable	Negro	\$250.00
1225	12W	127V	0.09	120°	1200	Regulable	Blanco	\$250.00
1230	15W	127V	0.025	120°	1500	Regulable	Negro	\$288.00
1235	15W	127V	0.025	120°	1500	Regulable	Blanco	\$288.00
1240	18W	127V	0.015	120°	1800	Regulable	Negro	\$320.00
1245	18W	127V	0.015	120°	1800	Regulable	Blanco	\$320.00

LÁMPARAS Y LINTERNAS LED DE EMERGENCIA



LUZ DE NOCHE CON FOTOCELDA
LUZ DE EMERGENCIA RECARGABLE
LUZ BLANCA
RECARGABLE A 127V

30,000 HORAS DE VIDA

Acabado:
Cuerpo de polímero plástico blanco
Difusor de acrílico transparente
Utiliza batería de Litio

Enciende automáticamente al fallar la energía eléctrica

Clave	Watts	Volts	Amp.	Apertura	Lumen	Temp.	Luz	Autonomía	Med. (axb/mm)	Empaque	Precio
LUE3L	3W	127V	0.03	105°	250	6500°K	LD	6 hrs.	335x30x40	20/10	\$155.00
LUM6L	5W	127V	0.06	105°	450	6500°K	LD	6 hrs.	450x50x40	20/10	\$290.00

LÁMPARA LED PARA CAMPING



35,000 HORAS DE VIDA

Acabado:
Cuerpo de polímero plástico rojo y negro
Difusor de acrílico transparente

Clave	Watts	Aper.	Lum.	Temp.	Luz	Aut.	Precio
LTLED2	1.2W	360°	90	6500°K	LD	6 hrs.	\$235.00

20/1

DRIVER LED



80,000 HORAS DE VIDA

Acabado:
Cuerpo de plástico color blanco
Características:
Frecuencia de operación 50/60 Hz

Clave	Watts	Volts	Tensión de salida	Med. (axb/c/mm)	Emp.	Precio
DRV4-6W	4/6W	85/265V	12DC a 300mA	67x25x20	500/1	\$33.00
DRV9-18W	9/18W	85/265V	12DC a 300mA	88x25x20	500/1	\$36.00
DRV20-24W	20/24W	185/265V	12DC a 300mA	88x25x20	400/1	\$40.00

SERIE CON PANEL SOLAR LED (con lámparas led incluidas)

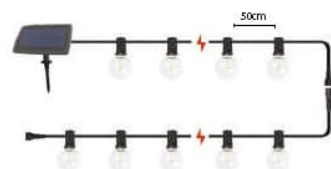

Dimensiones
Longitud: 9.1 mts. con 15 soquets
Distancia entre cada soquet 50 cm

Características:
Frecuencia de operación 50/60 Hz
Se puede cargar con:
-Panel solar
-Cable usb (incluido)
-Se pueden conectar hasta 2 series

Clave	Watts	Volts	Amp.	Temp.	Entrada	Luz	Emp.	Precio
SOL15E12	10W	127V	0.03	2700°K	E12	BC	12/6	\$880.00

Incluye:
15 Focos led G40 + 2 de repuesto
Acabado:
Cuerpo de plástico color negro



E-12

Dura de:
8-10 hrs con carga completa

Interruptor con 4 modos de iluminación:

- ✓ Brillante
- ✓ Intermitente
- ✓ Flash lento
- ✓ Flash rápido

Desde el panel puede conectar aparatos eléctricos por medio del USB
* Conectando por medio del panel el consumo es de 3.7 V*

Bajo precio

47



LUMINARIOS



LUMINARIO TIPO CANALETA Autobalastrado



Clave	Watts	Volts	Apertura	Med. (axbxc/mm)	Precio
CAN15	15W	127V	360°	600 x 33 x 48	\$125.00
CAN20	20W	127V	360°	700 x 33 x 48	\$130.00

Acabado: Canaleta con un balastro electrónico integrado en una de sus bases, cuerpo de aluminio, y accesorios incluidos.

Sugerencia de focos:

Lám para fluorescente T8 de 15W como el Mod. FL15D
Lám para fluorescente T8 de 20W como el Mod. FL20DT8



LUMINARIO TIPO CANALETA Autobalastrado



Clave	Watts	Volts	Apertura	Med. (axbxc/mm)	Precio
CAN40	40W	127V	360°	1320 x 33 x 48	\$99.00

Acabado: Canaleta con un balastro electrónico integrado en una de sus bases, cuerpo de aluminio, y accesorios incluidos.

Nota: Puede utilizar cualquier tubo fluorescente T8 y T12

Sugerencia de focos:

Lám para fluorescente T8 de 40W como el Mod. FL40DT8 y FL40LB



Luminarios de empotrar MR11 FIJO



Clave	Color	Base Inc.	Precio
EM8607/BL	Blanco	G24	\$37.00
EM8607/NE	Negro	G24	\$37.00
EM8607/SA	Satín	G24	\$44.00

Acabado: Cuerpo de aleación de aluminio con pintura en aplicación electrostática

Incluye:

- 1 Candado de alambre acerado
- 2 Pestañas con resorte
- 1 Base G24 de porcelana blanca con cable para una tensión de 12V hasta 130V
- 75 watts máximo

Nota: Lámpara no incluida



Luminarios de empotrar MR16 FIJO



Clave	Color	Base Inc.	Precio
EM8609/BLM	Blanco Mate	Gx5.3	\$37.00
EM8609/SA	Satín	Gx5.3	\$44.00

Acabado: Cuerpo de aleación de aluminio con pintura en aplicación electrostática

Incluye:

- 1 Candado de alambre acerado
- 2 Pestañas con resorte
- 1 Base Gx5.3 de porcelana blanca con cable para una tensión de 12V hasta 130V
- 75 watts máximo

Nota: Lámpara no incluida



Luminarios de empotrar MR16 DIRIGIBLE



Clave	Color	Base Inc.	Precio
EM1005/BL	Blanco	Gx5.3	\$43.00
EM1005/SA	Satín	Gx5.3	\$53.00

Acabado: Cuerpo de aleación de aluminio con pintura en aplicación electrostática

Incluye:

- 1 Candado de alambre acerado
- 2 Pestañas con resorte
- 1 Base Gx5.3 de porcelana blanca con cable para una tensión de 12V hasta 130V
- 75 watts máximo

Nota: Lámpara no incluida



Bajo precio



LUMINARIO DE EMPOTRAR EM73 Dirigible



Acabado: PVC blanco
Puede utilizar: lámpara LED, halógena e incandescente tipo MR16, GU10 o JDR

Nota: no incluye lámpara ni base

Clave	Watts	Volts	Aper.	Precio
EM73B	MAX. 75W	127V	120°	\$25.00

100/10

LUMINARIO DE EMPOTRAR EM74 Dirigible



Acabado: PVC blanco
Puede utilizar: lámpara LED, halógena e incandescente tipo MR16, GU10 o JDR

Nota: no incluye lámpara ni base

Clave	Watts	Volts	Aper.	Precio
EM74	MAX. 75W	127V	120°	\$31.00

100/10

LUMINARIOS GABINETE

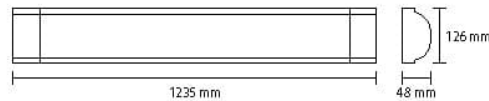

Clave	Volts	Apertura	Acabado	Precio
GRILL	85/220V	120°	Base reflectora de lámina de acero blanca Rejillas de acrílico platinado cromo 2 tapas laterales de PVC blancas	\$160.00

Nota: No incluye lámpara, ni balastro

Ventajas

- Apta para lámparas fluorescentes T8 de 32 o 36W que utilizan un balastro de 2x40W No incluido.
- Apta para 2 lámparas lineales LED T8 de 18W que ya tienen integrado el driver electrónico.

Incluye:

- 4 bases G13 para tubos T8
- Luminario precableado con cable de alimentación
- Kit de fijación para sobreponer

10/5

LÁMPARA SUBURBANA



IP65

Clave	Volts	Amp.	Aper.	Precio
SUB65	120V	0,472	180°	\$400.00

Acabado: Cuerpo de polímero plástico blanco
Difusor de acrílico facetado transparente

Nota: SUB65 NO INCLUYE LÁMPARA
Puede usar cualquier lámpara E-26

12/1

LÁMPARA SUBURBANA 30W



IP65

Clave	Watts	Volts	Amp.	Aper.	Lumen	Temp.	Luz	Precio
SUB30	30 W	120V	0,241	180°	1800	6400°K	LD	\$360.00

Acabado: Cuerpo de polímero plástico blanco
Difusor de acrílico facetado transparente

Nota: SUB30 INCLUYE LÁMPARA AHORRADORA

8/1

Bajo precio



LUMINARIOS A PRUEBA DE VAPOR PARA 1 TUBO Transparente y opalino

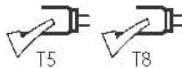
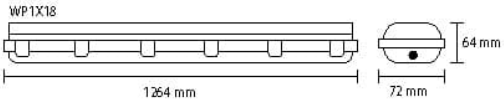
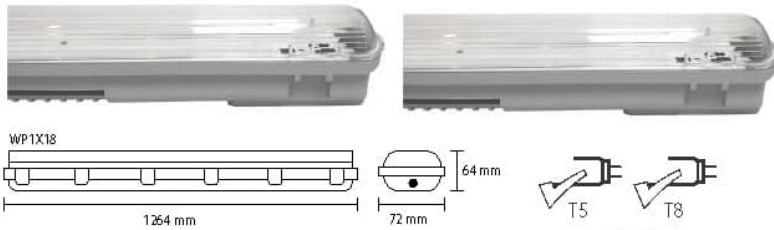

Clave	Volts	Amp.	Apertura	Cubierta	Precio
WP1X18	85/220V	0.283	180°	Transparente	\$195.00
WP1X18OP	85/220V	0.283	180°	Opalina	\$220.00

Incluye:
Kit de accesorios para sobreponer y suspender, cada lámpara contiene 2 bases G5 (T5) y 2 Bases G13 (T8)

Ventajas
• Apta para 1 lámpara lineal LED T5 o T8 con driver electrónico ya integrado

Nota: No incluye lámpara

Kit de accesorios

IP65



LUMINARIOS A PRUEBA DE VAPOR PARA 2 TUBOS Transparente y opalino

IP65

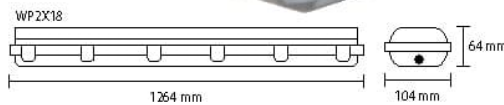

Clave	Volts	Amp.	Apertura	Cubierta	Precio
WP2X18	85/220V	0.283	180°	Transparente	\$268.00
WP2X18OP	85/220V	0.283	180°	Opalina	\$295.00

Incluye:
Kit de accesorios para sobreponer y suspender, cada lámpara contiene 4 bases G5 (T5) y 4 Bases G13 (T8)

Ventajas
• Apta para 1 lámpara lineal LED T5 o T8 con driver electrónico ya integrado

Nota: No incluye lámpara

Kit de accesorios



FAROS

IP65

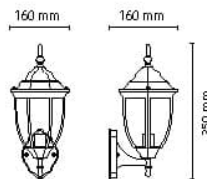

Clave	Watts	Volts	Amp.	Apertura	Color	Precio
FA80/NE	75 W MAX.	127V	0.590	360°	Negro	\$295.00
FA80/BL	75 W MAX.	127V	0.590	360°	Blanco	\$295.00

Acabado:
Cuerpo de metal con pintura en aplicación electrostática y secada al horno en colores blanco y negro. Difusor de vidrio transparente.

Nota: Puede utilizar cualquier lámpara E-26



Bajo precio

51



CANALETA AUTOBALASTRADA CON TUBO DESINFECTANTE Luz UV Germicida + Ozono



- Características:**
- Uso instantáneo
 - Sistema de adecuado para diferentes aplicaciones (hogar, áreas comunes, hospitales, escuelas, ductos de aire, etc)
 - Sencilla instalación, operación y mantenimiento

Acabado: Cuerpo de aluminio

Clave	Watts	Volts	Amp.	Luz	Precio
CAN40UVC	36W	100/130V	0,26	UVC	\$250.00

Elimina hasta el 99.9% de gérmenes, virus y bacterias



MICA PROTECTORA PLÁSTICA

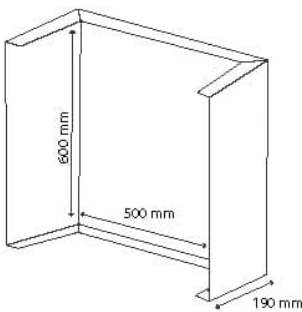

- Características:**
- Protección contra salpicaduras y gotas.
 - Doble cara con revestimiento antiniebla
 - Transparente
 - Reutilizable
 - Material PET

Clave	Med. (axb/mm)	Precio
5060	500 x 600 x 190	\$60.00

Incluye:
4 chupones para fijar



PORTALÁMPARAS DE EXTERIOR



Utiliza cualquier lámpara con base GX5.3

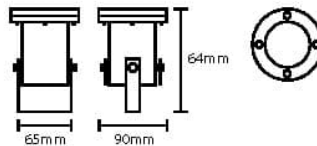

Acabado:
Cuerpo y disipador de calor en aluminio negro
Difusor de cristal transparente / Junta de silicona

Nota: Lámpara no incluida

Clave	Watts	Volts	Amp.	Precio	IP65
LUSUB/NE	75W MAX.	130/12V	0.59	\$199.00	

- Incluye:**
- Base GX5.3
 - Una entrada IP65 para cable de alimentación
 - Una base basculante para su fijación
 - Tornillos inoxidables



Utiliza cualquier lámpara con base E-26

Acabado:
Cuerpo de PVC color gris / Portalámparas precableada / Cuerda de 1/2 pulgada con 1 tuerca

Nota: Lámpara no incluida

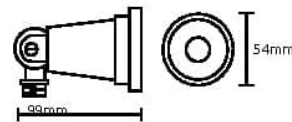

- Incluye:**
- Base para la lámpara E26
 - Rotula giratoria entre el cuerpo y la base
 - Empaque de hule para protección contra la humedad
 - Tornillos inoxidables

Clave	Watts	Volts	Amp.	Precio	IP65
PO526/GR	75W MAX.	127V	0.59	\$38.70	

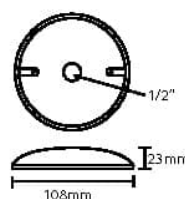

Clave	Precio	IP65
BA1/GR	\$25.00	



Bajo precio



CANAleta PARA TUBO T8 LED

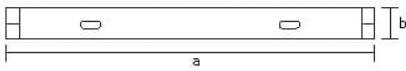

Acabado:
Cuerpo de lámina de acero con pintura blanca.

Características:
Base G13 y accesorios incluidos.
Se pueden interconectar hasta 10 canales.

* Electrificado por ambos lados

Clave	Volts	Descripción	Med. (axb/mm)	Empaque	Precio
* CAN60T8LED	127	Canaleta 1 x 60cm	610 x 33	50/10	\$45.00
* CAN120T8LED	100/230V	Canaleta Linkeable 1 x 120cm	1220 x 33	50/10	\$50.00
* CAN120T8LED/MO	100/230V	Canaleta 120cm (No Linkeable)	1220 x 33	50/1	\$40.00
CAN120T8LED/PL	100/230V	Canaleta linkeable 120cm (electrificado un solo lado)	1220 x 33	50/10	\$50.00
* CAN120T8X2LED/PL	100/230V	Canaleta 2 x 120cm	1220 x 71.5	40/1	\$50.00





**ESPECIALIDADES
VARIAS**

BALASTROS ELECTRÓNICOS MULTIWATAJE

Clave	Watts	Volts	Descripción	Med. (axbxc/mm)	Precio
BE1X8	1X4,6,8 W	127V	1X4,6 Y 8W T5	162X19,5X17,5	\$79.00
BE1X20	1X20 W	127V	1X15W A 20W T8 Y T12	122X43X25	\$107.00
BE1X40G10Q	1X40 W	127V	CIRCULAR 1X16W A 40W, T5, T9, T10	89X42X28	\$145.00
BE1X40	1X40 W	127V	1X17W A 40W, T5, T8, T12	89X42X28	\$145.00
BE2X28	2X28 W	127V	2X28W T5	210X28X22	\$190.00
BE2X40	2X40 W	127V	2X17W A 40W, T5, T8, T12	150X40X28	\$180.00
BE3X14	3X14 W	127V	3X14W T5	270X42X30	\$209.00
BE3X28	3X28 W	127V	3X28W T5	270X42X30	\$245.00

50/10

DETECTOR DE BILLETES FALSOS

Clave	Watts	Volts	Amp.	Aper.	Luz	Precio
MDPL7	7W	127V	0.055	120°	UV	\$290.00

Incluye:

- Lámpara fluorescente de luz ultravioleta (UV conocida como luz negra)
- Balastro electrónico integrado
- Un cable con clavija integrado

Acabado: Cuerpo de plástico ABS negro / Difusor de aluminio semiespecular.

24/1

APARATO CILINDRICO DOMÉSTICO PARA ELECTROCUTAR INSECTOS

Clave	Watts	Volts	Amp.	Luz	Precio
IN1X6/NE	6W	127V	0.047	UV	\$300.00

Acabado: Cuerpo Plástico ABS de color negro con rejilla protectora. Rejillas de alambre acerado en la parte interior.

Incluye:

- 1 lámpara fluorescente de luz ultravioleta (UV)
- Balastro de electrocución electrónico integrado
- Cable con clavija integrado

10/5

APARATO PARA ELECTROCUTAR INSECTOS con tubos de leds



✓ Longitud de onda: 365 nm

Se ha demostrado científicamente que la longitud de onda de los 365 nm atrae a los insectos debido a que es su dimensión en visión natural, esto ocasiona que no puedan resistirse a ser atraídos por la luz de la lámpara.

Acabado: Cuerpo Plástico ABS de color gris y rejillas de alambre acerado cromado en las dos caras.

Incluye:

- 2 lámparas LED de luz ultravioleta (UV)
- Balastro de electrocución electrónico integrado
- Cable con clavija integrado

Clave	Watts	Volts	Amp.	Med. (mm)	Luz	Precio
INLED4	8W	127V	0.034	36,8X24x4,4	UV	\$550.00

10/1

TIMBRE DING DONG

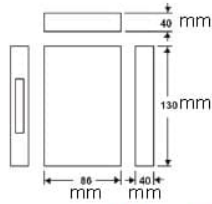

V **\$**
Volts Precio

Clave

YW-5

127V \$95.00

Acabado: Cuerpo de plástico ABS de color blanco.
Incluye: • Balastro electrónico integrado



SERIE PARA LÁMPARAS E26 (TIPO "T") 7.5 Mts.

IP54



SE PUEDEN INTERCONECTAR HASTA 3 SERIES

DISTANCIA ENTRE CADA SOQUET 63CM

W **V** **A** **Soquets Base** **Empaque** **\$**
Watts Volts Amp. Soquets Base Empaque Precio

Clave

7.5M12

800W MÁX. 127V 4.74 12 pzas. E-26 8/4 \$500.00

Características:

- Tipo de colocación: de sobreponer
- Cable y soquet en color negro
- Altura de cada línea de 20 centímetros
- Uso interior y exterior

NOTA:

Lámparas no incluidas

FOTOCELDA para uso multiple

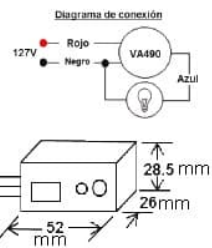

W **V** **A** **\$**
Watts Volts Amp. Precio

Clave

VA490

100 W MÁX. 127V 0.787 \$73.00

Acabado: Cuerpo de plástico ABS negro



FOTOCELDA para uso exterior



W **V** **A** **Luz** **\$**
Watts Volts Amp. Luz Precio

Clave

FC1000

1500W MAX. 127/240V 0.047 LD \$83.00

Características:

- Tipo de colocación:
- Giro de conexión
- Cuerpo de plástico ABS azul

Nota: Se coloca en una base para fotocelda mod.FC100 no incluida, se pide por separado.



BASE PARA FOTOCELDA con escuadra

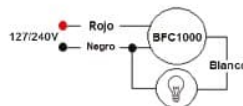
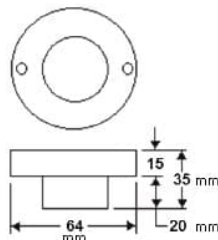

Clave

BFC1000

V **\$**
Volts Precio

100/277V \$58.00

Características:

- Tipo de colocación: De sobreponer
- Cuerpo de plástico ABS negro
- Incluye: • Tres cables para su correcta conexión

Nota:

Es el complemento de la fotocelda mod.FC1000 no incluida, se pide por separado.





ARTEFACTOS ELECTRICOS

PORTALÁMPARAS

PO101

Block Soquet Porcelana E-12

1000/50

\$ 3.80



Producto Portalámpara
Volts 127 / 220 V ~
Watts 660 W
Base E-12
Material Porcelana
Color Blanco

PO107

Block Soquet de Porcelana

1000/50

\$ 6.00



Producto Portalámpara
Volts 127 V ~
Watts 660 W
Base E-17
Material Porcelana
Color Blanco

PO110

Block Soquet Porcelana E-10

1000/50

\$ 3.30



Producto Portalámpara
Volts 127 / 220 V ~
Watts 660 W
Base E-10
Material Porcelana
Color Blanco

PO111

Block Soquet Porcelana E-14

1000/50

\$ 4.30



Producto Portalámpara
Volts 127 / 220 V ~
Watts 660 W
Base E-14
Material Porcelana
Color Blanco

PO127

Soquet Porcelana Anuncio E-26

240/20

\$ 6.40



Producto Portalámpara
Volts 127 / 250 V ~
Watts 660 W
Base E-26
Material Porcelana
Color Blanco

PO128

Soquet Porcelana c/ cables y bisagra E-26

400/20

\$ 5.80



Producto Portalámpara
Volts 127 / 250 V ~
Amperes 660 W
Base E-26
Material Porcelana
Color Blanco

PO129

Soquet Porcelana c/cables E-26

400/20

\$ 5.00



Producto Portalámpara
Volts 127 / 250 V ~
Amperes 660 W
Base E-26
Material Porcelana
Color Blanco

PO130

Soquet Porcelana Cuadrado E-26

240/20

\$ 6.30



Producto Portalámpara
Volts 127 / 250 V ~
Watts 660 W
Base E-26
Material Porcelana
Color Blanco

PO131

Soquet Convertidor E-26 a E-40

80/10

\$ 29.30



Producto Portalámpara
Convertidor
Volts 127 / 240 V ~
Watts 660 W
Base E-26 a E-40
Material Porcelana
Color Blanco

PO132

Block Soquet E-26 (1/2) 92.5 mm

120/10

\$ 14.00



Producto Portalámpara
Volts 127 / 250 V ~
Watts 660 W
Base E-26
Material Porcelana
Color Blanco

PO133

Block Soquet E-26 (3/4) 102 mm

80/10

\$ 15.70



Producto Portalámpara
Volts 127 / 250 V ~
Watts 660 W
Base E-26
Material Porcelana
Color Blanco

PO171

Soquet Convertidor E-40 a E-26

200/20

\$ 17.40



Producto Portalámpara
Convertidor
Volts 127 / 240 V ~
Watts 660 W
Base E-40 a E-26
Material Porcelana
Color Blanco

PO178

Adaptador Moldeado E-26 a E-40

1000/100

\$ 8.00



Producto Adaptador
Moldeado
Volts 127 - 240 V ~
Base E-26 a E-40
Material Aluminio
Color Aluminio

PO210

Soquet convertidor E-26 - GU10

1000/20

\$ 12.00



Producto Portalámpara
Convertidor
Volts 127 V ~
Amperes 3A
Base E-26 a GU10
Material Plástico
Color Blanco

PO215

Soquet convertidor E-26 - G5.3

2000/20

\$ 12.00



Producto Portalámpara
convertidora
Volts 127 V ~
Amperes 3A
Base E-26 a G5.3
Material Plástico
Color Blanco

Bajo precio

PO226

Soquet Rotativo E-26



\$ 17.40



Producto Portalámpara
Volts 127 / 250 V~
Watts 250 W
Base E-26
Material Baquelita
Color Negro

PO227

Soquet Ladrón E-26



\$ 9.00



Producto Portalámpara
Volts 127 / 250 V~
Watts 660 W
Base E-26
Material Baquelita
Color Negro

PO227C

Soquet Ladrón con Cadena E-26



\$ 14.70



Producto Portalámpara
Volts 127 V~
Watts 660 W
Base E-26
Material Baquelita
Color Café

PO228

Soquet de Baquelita Sencillo E-26



\$ 6.00



Producto Portalámpara
Volts 127 V~
Watts 660 W
Base E-26
Material Baquelita
Color Café

PO230

Soquet Doble "Y" E-26



\$ 14.90



Producto Portalámpara
Volts 127 / 250 V~
Watts 660 W
Base E-26
Material Baquelita
Color Negro

PO240

Portalámpara con clavija



\$ 7.50



Producto Portalámpara
Volts 127 V~
Amperes 15A
Base E-26
Material Baquelita
Color negro

PO327

Portalámparas de Porcelana
c/ cubierta de Hule E-26



\$ 5.40



Producto Portalámpara
Volts 127 / 250 V~
Watts 660 W
Base E-26
Material Porcelana
Color Negro

PO410

Soquet de Plástico colgante



\$ 3.80



Producto Portalámpara
Volts 127 V~
Watts
Base E-12
Material Plástico
Color Verde

BASES

BFL477

Base Fluorescente tipo Chupón



\$ 8.00



Producto Base
Fluorescentes
T8
Tubo G13
Base Plástico ABS
Material Blanco
Color Chupón
Tipo

BFL480

Base Fluorescente Larga



\$ 5.80



Producto Base
Fluorescente
Tubo T8 y T12
Base G13
Material Plástico ABS
Color Blanco
Tipo FL Larga

BFL482

Base Fluorescente Corta



\$ 5.30



Producto Base
Fluorescentes
T8
Tubo G13
Base Plástico ABS
Material Blanco
Color FL Corta
Tipo

BFL483

Base Fluorescente Mini



\$ 4.90



Producto Base
Fluorescente
T5
Tubo G13
Base Plástico ABS
Material Blanco
Color FL Mini
Tipo

BFL485

Base Fluorescente Móvil



\$ 5.50



Producto Base
Fluorescente
Tubo T8
Base G13
Material Plástico ABS
Color Blanco
Tipo Móvil

BFL486

Base Fluorescente Fija (mini)



\$ 5.80



Producto Base
Fluorescente
T5
Tubo G5
Material Plástico ABS
Color Blanco
Tipo Fija Mini

BFL490

Base fluorescente c/ base para tubo



\$ 4.70



Producto Base
Base T8
Material Plástico
Color Blanco

BFL491

Base fluorescente c/ base para tubo



\$ \$4.10



Producto Base T5
Material Plástico
Color Blanco

GU10

Base p/lámpara entrada GU10



\$ \$13.00



Producto Base GU10
Material Plástico
Color Blanco

G9

Base p/lámpara entrada G9



\$ \$16.00



Producto Base G9
Material Plástico
Color Blanco

LMSK

Base rectangular p/ MR16 y MR11



\$ \$6.00



Producto Base MR16/ MR11
Material Plástico
Color Blanco

LMSKR

Base redonda p/ MR16 y MR11



\$ \$6.00



Producto Base MR16/ MR11
Material Plástico
Color Blanco

H118

Base c/ cables p/tubo cuarzo 118mm



\$ \$16.50



Producto Base RS7
Material Porcelana
Color Blanco

CLAVIJAS Y CONTACTOS

CO273

Contacto industrial 2Pp+T hule con abrazaderas



\$ \$12.00



Producto Contacto Industrial
Volts 127 V ~
Amperes 15A
Conexión 2 P+T
Material Plástico ABS
Color Negro

CO275B

Contacto Duplex 2P+T



\$ \$10.00



Producto Contacto 127 V ~
Volts 15 Amp.
Amperes 15 Amp.
Tipo Oculto
Material Metal
Plástico ABS
Color Blanco

CO275M

Contacto Duplex Polarizado 2P+T



\$ \$10.00



Producto Contacto 127 V ~
Volts 15 Amp.
Amperes 15 Amp.
Tipo Oculto
Material Metal
Plástico ABS
Color Marfil

CO275NA

Contacto Duplex Naranja



\$ \$33.00



Producto Contacto 127 V ~
Volts 15 Amp.
Amperes 15 Amp.
Tipo Oculto
Grado Ind.
Material Metal/Plás.ABS
Color Naranja

CO278

Contacto Duplex Sobreponer 2P+T



\$ \$13.20



Producto Contacto 127 V ~
Volts 15 Amp.
Amperes 15 Amp.
Tipo Sobreponer
Material Metal
Plástico ABS
Color Marfil

CO279

Contacto Ovalado Hule Colgante



\$ \$8.10



Producto Contacto 127 V ~
Volts 15 Amp.
Amperes 15 Amp.
Tipo Polarizado
Material Hule
Color Negro

CO280

Contacto Triple con Clavija



\$ \$10.70



Producto Contacto 127 V ~
Volts 15 Amp.
Amperes 15 Amp.
Tipo Triple c/ clav.
Material Plástico
Color Marfil

CO281

Contacto Triple para Extensión



\$ \$10.00



Producto Contacto 127 V ~
Volts 15 Amp.
Amperes 15 Amp.
Tipo Triple p/ext.
Material Plástico
Color Marfil

CO282

Contacto Triple de Bisagra



\$ \$16.90



Producto Contacto 127 V ~
Volts 20 Amp.
Amperes 20 Amp.
Tipo Triple c/Bis.
Material Plástico
Color Marfil

CO285NA

Contacto Duplex Grado Hospital

200/10

\$ \$85.00



Producto Contacto
Volts 127 V~
Amperes 20 Amp.
Tipo Oculto Hospital
Material Metal
Color Plástico ABS Naranja

CL473

Clavija industrial 2P+T hule
Con abrazaderas

400/10

\$ \$9.00



Producto Clavija
Volts 127 V~
Amperes 15A
Conexión 2 P+T
Material Plástico ABS
Color Negro

CL477N

Clavija Convertidora 2P+T

1200/120

\$ \$4.60



Producto Clavija Convertidora
Volts 127 V~
Amperes 15 Amp.
Tipo 2P+T
Material Hule
Color Naranja

CL478

Clavija Ovalada 2P Plana

500/50

\$ \$7.00



Producto Clavija
Volts 127 V~
Amperes 15 Amp.
Tipo 2P Plana
Material Hule
Color Negro

CO483

Contacto Sencillo Linea Basic

500/50

\$ 6.80



Producto Contacto Ind.
Volts 127 V~
Amperes 15 Amp.
Tipo 2P+T
Material Metal / Plástico ABS
Color Marfil

LMADP

Clavija convertidora redondo a plano

2000/50

\$ \$12.00



Producto Clavija
Volts 127 V~
Amperes 15 Amp.
Tipo convertidora
Material Plástico
Color Blanco

PLACAS

LMADR

Clavija convertidora plano a redondo

1000/50

\$ \$12.00



Producto Clavija
Volts 127 V~
Amperes 15 Amp.
Tipo Convertidora
Material Plástico
Color Blanco

PLA400

Placa Ciega

1000/50

\$ \$4.80



Producto Placa
Tipo Ciega
Material Plástico ABS
Color Blanco

PLA401B

Placa Duplex

1000/100

\$ \$3.70



Producto Placa Doble
Tipo Duplex
Material Plástico ABS
Color Blanco

PLA401M

Placa Duplex

1000/100

\$ \$3.70



Producto Placa Doble
Tipo Duplex
Material Plástico ABS
Color Marfil

PLA401NA

Placa Duplex

1000/100

\$ \$4.20



Producto Placa Doble
Tipo Duplex
Material Plástico ABS
Color Naranja

PLA422

Placa plastica duplex intertemperie

200/10

\$ \$16.50



Producto Placa Doble
Tipo Duplex
Material Plástico
Color Gris

INTERRUPTORES

IN278

Interruptor de Push

2500/50

\$ \$5.70



Producto Interruptor
Volts 125 V~
Amperes 3 Amp.
Tipo Push
Material Plástico
Color Negro

IN279

Balancín Redondo

5000/50

\$ \$7.00



Producto Interruptor
Volts 125/250 V~
Amperes 3 / 6 Amp.
Tipo Balancín
Material Plástico
Color Negro

IN280

Balancín Redondo con Piloto

2500/50

\$ \$7.50



Producto Interruptor
Volts 125 / 250 V~
Amperes 13 / 6.5 Amp.
Tipo Balancín
Material Plástico
Color Negro

IN281

Interruptor de Palanca on/off 2 Tornillos

 500/50  \$18.70



Producto Interruptor
Volts 125 / 250 V~
Amperes 10 / 6 Amp.
Tipo Palanca
Material Metal/Baq.
Color Negro

IN282

Interruptor de Palanca Cola de Rata

 1000/50  \$15.20



Producto Interruptor
Volts 125 / 250 V~
Amperes 6 / 3 Amp.
Tipo Palanca
Material Metal/Baq.
Color Negro

IN283

Interruptor Tecla Cuadrado



 4000/50  \$4.10



Producto Interruptor
Volts 125 / 250 V~
Amperes 10 / 6 Amp.
Tipo Tecla
Material Plástico
Color Negro

IN284

Interruptor Tecla Cuadrado



 4000/50  \$5.30



Producto Interruptor
ON-OFF 3P
Volts 125/250V~
Amperes 20/16 Amp.
Tipo Tecla
Material Plástico
Color Negro

IN285

Int. Tecla Cuadrado c/luz Piloto



 2500/50  \$5.70



Producto Interruptor
ON-OFF 3P
Volts 125/250V~
Amperes 20/16 Amp.
Tipo Tecla
Material Plástico
Color Negro

IN286

Interruptor de Palanca 6 Tornillos

 500/50  \$22.50



Producto Interruptor
ON-OFF
Volts 125/250 V
Amperes 10/6 Amp
Tipo Palanca
Material Metal
Color Plata

IN287

Interruptor de Palanca 4 Tornillos

 500/50  \$23.50



Producto Interruptor
ON-OFF
Volts 125/250 V
Amperes 10/6 Amp.
Tipo Palanca
Material Metal
Color Plata

IN288

Interruptor de Palanca 3 Tornillos

 500/50  \$17.80



Producto Interruptor
ON-OFF
Volts 125/250 V
Amperes 10/6 A
Tipo Palanca
Material Metal
Color Plata

IN290

Interruptor con cadena y cables
(2 posiciones on / off)



 1000/100  \$16.00



Producto Interruptor
Volts 125/250 V~
Amperes 3A
Conexión Cable 10 cm
Material Plástico
Color Negro

IN295

Combinación Apagador / Contacto

 200/10  \$22.00



Producto Interruptor
Volts 127 V~
Amperes 15 Amp.
Tipo Apag./Cont +T
Material Metal /
Plástico ABS
Color Marfil

IN472

Interruptor de paso tecla

 2000/100  \$3.90



Producto Interruptor
Volts 127 V~
Amperes 3A
Conexión 18 AWG 2C
Material Plástico
Color Negro

IN475

Interruptor de Paso Deslizable

 1200/30  \$5.80



Producto Interruptor
Volts 125 / 250 V~
Amperes 3 Amp.
Tipo Deslizable
Material Plástico
Color Blanco

IN476

Interruptor de Paso Tecla

 600/24  \$8.00



Producto Interruptor
Volts 127 / 250 V~
Amperes 3 Amp.
Tipo Pera
Material Plástico
Color Marfil

IN478

Interruptor Sencillo Linea Basiq

 1000/50  \$6.80



Producto Interruptor
Volts 127 V~
Amperes 10 Amp.
Tipo Sencillo
Material Plástico
Color Marfil

ARRANCADORES

FS2

Arrancadores Plásticos "FS"



2000/25



\$4.00



Producto Arrancador
Volts 130 V~
Watts 4 W / 20 W

FS4

Arrancadores Plásticos "FS"



1000/25



\$4.90



Producto Arrancador
Volts 130 V~
Watts 30 W / 40 W

FSU

Arrancadores Plásticos "FS"



2000/25



\$9.70



Producto Arrancador
Volts 220 V~
Watts 4 W / 80 W

VARIOS

SUT8

Clip sujetador de acrílico transparente para tubo T8



5000/100



\$3.80



Producto Clip
Material Acrílico
Color Transparente

Contamos con:
EXHIBIDORES DE ARTEFACTOS
DISPONIBLES

Pregunte a su representante
de ventas términos y condiciones



105 cm

70 cm



OFERTAS

LOS PRECIOS EN ESTA SECCIÓN DE OFERTAS SON MÁS IVA, NO INCLUYEN NINGÚN DESCUENTO ADICIONAL.

ST6 STROBO



Clave	Watts	Volts	Amp.	Aper.	Temp.	Luz	Precio
ST6/TR	6W	127V	0.047	360°	-	Blanca	\$75.00
ST6/RO	6W	127V	0.047	360°	-	Roja	\$75.00

Acabado: Cuerpo de plástico blanco.
 Difusor de plástico facetado rayado.
 ST6/TR: Transparente
 ST6/RO: Rojo Fuente luminosa de XENÓN

50/1

MR11 con cubierta



Clave	Watts	Volts	Amp.	Aper.	Temp.	Luz	Precio
MR11FTIC	50 W	12V	4.166	38°	3000°K	Cálida	\$5.90

Acabado: Cuerpo de cristal platinado
 Difusor (cubierta) de cristal transparente

250/25

T5 Tubos Fluorescentes

IP20

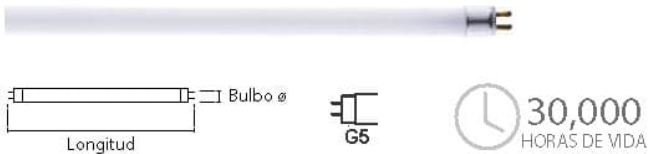

Clave	Diametro	Bulbo	Watts	Volts	Amp.	Aper.	Luz	Emp.	Precio
FL13BC	531mm	T5/16mm	13 W	127V	0.102	360°	Cálida	200/10	\$6.00
FL54BCT5	1163mm	T5/16mm	54 W	127V	0.425	360°	Cálida	100/25	\$25.00

*VERNOTA

T4 Tubos Fluorescentes

IP20

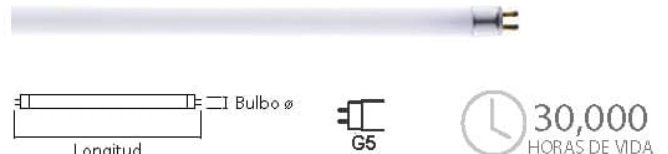

Clave	Longitud	Bulbo	Watts	Volts	Amp.	Aper.	Luz	Precio
FL20BCT4	565 mm	T4/12.5mm	20W	130V	0.157	360°	Cálida	\$18.00

*VERNOTA

100/10

T20 GU10 SMD RESINA

POWER LED



Clave	Watts	Volts	Amp.	Aper.	Lumen	Temp.	Luz	Precio
GU10R3SMD/BC	3W	85/265V	0.023	360°	180	2700°K	BC	\$23.00

Acabado: Cuerpo y difusor de resina transparente

200/10

S14 LED

LED SMD



Clave	Watts	Volts	Amp.	Luz	Precio
S14SMD4/MO	4 W	127V	360°	Morado	\$25.00

100/10

*NOTA: El voltaje y el amperaje indicados no son de la lámpara, sino que es el correspondiente entre el voltaje de entrada del balastro y el consumo (Watts) de la lámpara.

LOS PRECIOS EN ESTA SECCIÓN DE OFERTAS SON MÁS IVA, NO INCLUYEN NINGÚN DESCUENTO ADICIONAL.

Ilumina tus espacios

GU10 COB



GU10

50,000 HORAS DE VIDA

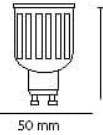

Watts
 Volts
 Lumen
 Aper.
 Luz
 Precio

Clave

GU10COB7/BC 7W 110/220V 560 120° BC **\$29.00**

50/10

GU10 LED DIMEABLE



GU10

50,000 HORAS DE VIDA

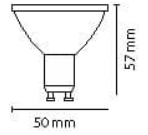

Watts
 Volts
 Aper.
 Lum.
 Temp.
 Luz
 Precio

Clave

GU10SMD5DIM/BC 5 W 127V 120° 330 2700°K BC **\$25.00**

200/10

ST64 DECORATIVO COPPER WIRE LED

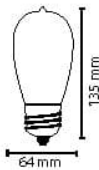

E-26

25,000 HORAS DE VIDA



Watts
 Volts
 Amp.
 Aper.
 Temp.
 Luz
 Precio

Clave

ST64CP/LD 1.5 W 127V 0.031 360° 6500°K LD **\$68.00**

Acabado:

Difusor de cristal transparente

*Cambio cíclico de colores

100/10

TUBULAR TIPO VENTILADOR LED con luz al centro

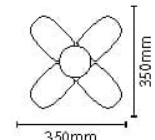

E-26

25,000 HORAS DE VIDA



Watts
 Volts
 Amp.
 Aper.
 Lum.
 Temp.
 Luz
 Med. (lux/ft²/mm)
 Precio

Clave

FAN50+7 57W 85/265V 0.5 180° 3600 6400°K LD 350x234 **\$109.00**

Acabado:

Cuerpo de aluminio y PVC blanco

Difusor de acrílico opalino

40/5

T8 LED Slim FA8 Transparente y Opalino 120cm



Transparente / T8SMD1 20CFA8



Opalino / T8SMD1 20CFA8OP

FA8

50,000 HORAS DE VIDA

Watts
 Volts
 Amp.
 Aper.
 Lum.
 Temp.
 Luz
 Precio

Clave

T8SMD120CFA8/LDD 18W 85/265V 0.141 110° 1500 6500°K LD **\$49.00**
T8SMD120CFA8OP/LDD 18W 85/265V 0.141 110° 1500 6500°K LD **\$49.00**

25/5



Acabado:

Difusor de cristal

Disipador de calor de aluminio

*NOTA: El voltaje y el amperaje indicados no son de la lámpara, sino que es el correspondiente entre el voltaje de entrada del balastro y el consumo (Watts) de la lámpara.



Ilumina tus espacios

LOS PRECIOS EN ESTA SECCIÓN DE OFERTAS SON MÁS IVA, NO INCLUYEN NINGÚN DESCUENTO ADICIONAL.

LUMINARIO LED para empotrar y sobreponer



35,000 HORAS DE VIDA

Watts	Volts	Aper.	Lum.	Luz	Precio

Clave							
BEMMY	5 W	100/230V	45°	380	BC		\$119.00

Nota: Driver Incluido



LUMINARIO LED para empotrar



35,000 HORAS DE VIDA

Watts	Volts	Aper.	Lum.	Luz	Precio

Clave							
INTENSE	7W	100/230V	130°	530	BC		\$199.00

Nota: Driver Incluido



LUMINARIO LED para empotrar



35,000 HORAS DE VIDA

Watts	Volts	Aper.	Lum.	Luz	Precio

Clave							
TRIARA	20 W	100/230V	130°	1575	BC		\$399.00

Nota: Driver Incluido



LUMINARIO DE LED para empotrar

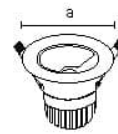

20,000 HORAS DE VIDA

Watts	Volts	Lumen	Temp.	Med. (mm)	Luz	Precio

Clave							
COBY15/BC	15W	100/230V	1275	3000°K	160	BC	\$169.00
COBY15/LD	15W	100/230V	1275	6500°K	160	LD	\$169.00
COBY20/BC	20W	100/230V	1700	3000°K	200	BC	\$199.00
COBY20/LD	20W	100/230V	1700	6500°K	200	LD	\$199.00

Nota: Driver Incluido



LUMINARIO para empotrar 18W



20,000 HORAS DE VIDA

Watts	Volts	Aper.	Lum.	Luz	Precio

Clave							
EMSMD18/BC	8W	100/230V	120°	1400	BC		\$179.00

Nota: No incluye cable



LUMINARIOS a prueba de vapor



20,000 HORAS DE VIDA

Watts	Volts	Aper.	Lum.	Med. (axb/mm)	Luz	Precio

Clave							
HYDRO40	7W	85/265V	120°	3000	120x86x66	LD	\$459.00

Nota: No incluye cable



*NOTA: El voltaje y el amperaje indicados no son de la lámpara, sino que es el correspondiente entre el voltaje de entrada del balastro y el consumo (Watts) de la lámpara.



OFERTAS

PANEL LED CUADRADO para empotrar

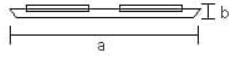

35,000 HORAS DE VIDA



Clave	Watts	Volts	Amp.	Aper.	Lumen	Temp.	Luz	Med.	Precio
CUAD7/BC	7W	85/265V	0.11	105°	300	3000°K	BC	100x100	\$32.00

Acabado:

Cuerpo de aluminio blanco
Difusor de acrílico opalino



SENSOR DE MOVIMIENTO



Clave	Watts	Volts	Alcance	Apagado	Aper.	Precio
R58C	800W MÁX.	127V	5M	10 seg. a 6 min.	360°	\$169.00



Acabado: Cuerpo de acrílico plástico blanco.

Cualidades: Para sobreponer en techo.

Detecta el movimiento mediante luz infrarroja (calor).

Es ajustable para detección de luz (día y noche) y el tiempo de apagado.

Funciona con lámparas incandescentes, fluorescentes, halógenas y LED.

LUMINARIO CAMPANA E-26



Clave	Volts	Apertura	Precio
AR89/PL	127V	120°	\$120.00



Acabado: Cuerpo de aluminio. Nota: Lámpara no incluida.
Puede utilizar cualquier lámpara con entrada E-26

SOQUET CON CABLE DECORATIVO Tipo Vintage

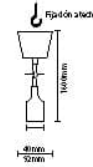

Clave	Watts	Volts	Amp.	Recubrimiento	Base	Precio
FA95C	75W MÁX.	127V	0.990	SILICÓN	E-26	\$80.00

Características

- Material del cable: Silicón negro
- Soquet recubierto de silicón negro
- Material de la base del techo: Plástico negro
- Incluye una armella para fijación a techo



Nota: Ideal para lámpara tipo vintage con base E26

GLOSARIO



Íconos y su significado

- | | |
|---------------------------|--|
| Watts | Medidas (Todo expresado en mm) |
| Volts | Potencia luminosa (Lumenes) |
| Amperaje | Empaque |
| Angulo de apertura de luz | IP es el grado de protección contra el ambiente |
| Temperatura de color | El producto tiene la capacidad de cambiar de colores (RGB) |
| Luz que emite | El producto tiene la capacidad regular la portencia luminosa |

Tipos de entradas que tienen nuestros productos

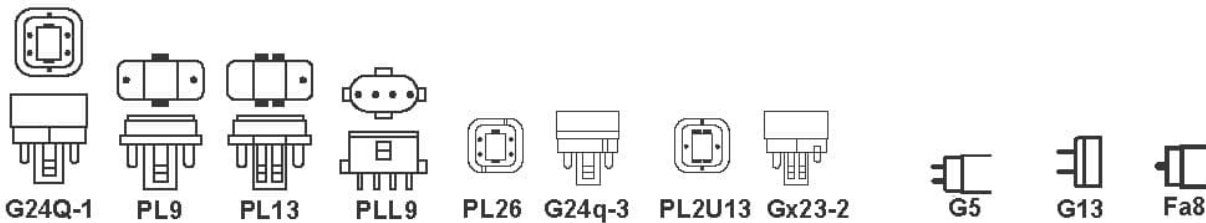

Temperaturas de color e iconografía dentro del catálogo



BC: Blanco Cálido BN: Blanco Neutro LD: Luz de Día



SELECCIONA FÁCILMENTE LA LUZ DE LA LÁMPARA





Ilumina tus espacios



MATRIZ
San Andrés Atoto No. 13
Col. Industrial Atoto
C.P. 53519, Naucalpan
Estado de México



Conmutador : 55.5358.5800



ventas@lummi.com.mx
cyc@lummi.com.mx
(Crédito y cobranza)

